



SPL
Brigham and Women's Hospital
Boston, Massachusetts USA

a teaching affiliate of
Harvard Medical School

3D VISUALIZATION OF DICOM IMAGES FOR RADIOLOGICAL APPLICATIONS

Sonia Pujol, PhD

Brigham and Women's Hospital, Harvard Medical School

Kitt Shaffer, MD, PhD

Boston University School of Medicine, Boston University

Ron Kikinis, MD,

Brigham and Women's Hospital, Harvard Medical School



Course Overview

Part I: Introduction to the 3D Slicer software

Part II: 3D Data Loading and visualization of DICOM images

Volume Rendering of thoraco-abdominal CT data

Surface Rendering of MR head data

Part III: 3D interactive exploration of the anatomy

Interactive Exploration of the Segments of the liver

Interactive Exploration of the Segments of the lung

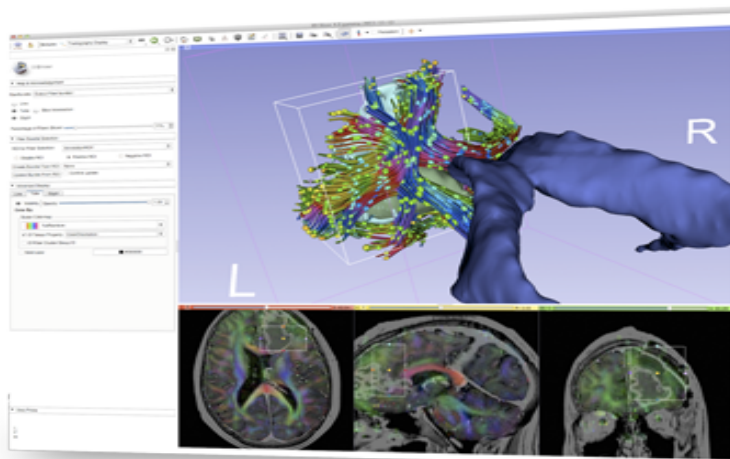

Part I:

Introduction to the 3D Slicer
open-source software



Slicer 18th year Anniversary

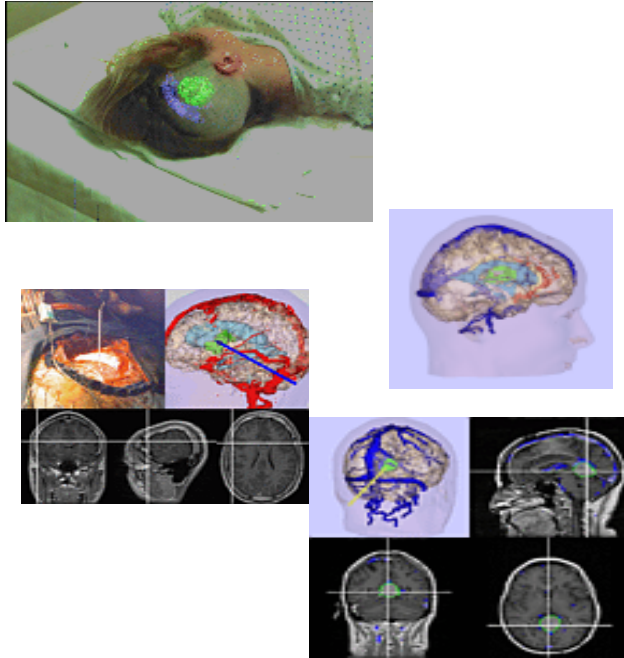

- 1997: Slicer started as a Master's thesis between the Surgical Planning Lab at Harvard and the CSAIL at MIT

Image Courtesy of the CSAIL, MIT



Slicer 18th year Anniversary

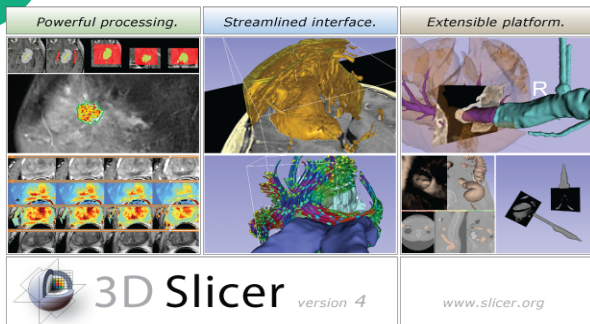

- 1997: Slicer started as a Master's thesis between the Surgical Planning Lab at Harvard and the CSAIL at MIT

Slicer4 download stats 164,290



- 2015: International open-source platform used in clinical research worldwide. P.I. Prof. Ron Kikinis, BWH, Harvard



3D Slicer



Download Slicer4

the free cross-platform open-source medical image processing and visualization system

You are one click away from downloading 3D Slicer, a free and open-source platform for analyzing and understanding medical image data. Created through multiple grants from the US National Institutes of Health (NIH) over almost two decades, Slicer brings powerful medical image processing, visualization, and data analysis tools within reach of everyone.

Slicer is built and tested on many hardware and software platforms. 3D Slicer runs on modern Windows, Mac OS X (10.7 and up), and a variety of Linux distributions.

Installers

	Windows	Mac OS X	Linux
Stable Release	version 4.5.0-1 revision 24725 built 2015-11-12	version 4.5.0-1 revision 24725 built 2015-11-12	version 4.5.0-1 revision 24725 built 2015-11-12
Nightly Build	version 4.5.0+ revision 24775 built 2015-11-26	version 4.5.0+ revision 24775 built 2015-11-26	version 4.5.0+ revision 24775 built 2015-11-26

Resources

For everyone

- [Slicer home](#)
- [Slicer wiki](#)
- [General help](#)
- [Reporting problems](#)
- [Acknowledgements](#)
- [License](#)
- [Contact us](#)

For users

- [Training and tutorials](#)
- [User documentation](#)
- [Slicer in use](#)
- [User email list](#)

For developers

- [Development overview](#)
- [Building from source](#)
- [Quality dashboard](#)
- [Developer email list](#)
- [Download statistics](#)

Content of this site is Copyright BWH and 3D Slicer contributors, unless otherwise noted. Contact webmaster@bwh.harvard.edu for questions about the use of this site's content.

- Slicer is a **freely available open-source** application for viewing, analyzing and interacting with biomedical imaging data



3D Slicer



Download Slicer4

the free cross-platform open-source medical image processing and visualization system

You are one click away from downloading 3D Slicer, a free and open-source platform for analyzing and understanding medical image data. Created through multiple grants from the US National Institutes of Health (NIH) over almost two decades, Slicer brings powerful medical image processing, visualization, and data analysis tools within reach of everyone.

Slicer is built and tested on many hardware and software platforms. 3D Slicer runs on modern Windows, Mac OS X (10.7 and up), and a variety of Linux distributions.

Installers

	Windows	Mac OS X	Linux
Stable Release	version 4.5.0-1 revision 24725 built 2015-11-12	version 4.5.0-1 revision 24725 built 2015-11-12	version 4.5.0-1 revision 24725 built 2015-11-12
Nightly Build	version 4.5.0+ revision 24775 built 2015-11-09	version 4.5.0+ revision 24775 built 2015-11-09	version 4.5.0+ revision 24775 built 2015-11-09

Resources

For everyone

- Slicer home
- Slicer wiki
- General help
- Reporting problems
- Acknowledgements
- License
- Contact us

For users

- Training and tutorials
- User documentation
- Slicer in use
- User email list

For developers

- Development overview
- Building from source
- Quality dashboard
- Developer email list
- Download statistics

Content of this site is Copyright BWH and 3D Slicer contributors, unless otherwise noted. Contact webmaster@bwh.harvard.edu for questions about the use of this site's content.

- Slicer is a **freely available open-source** application for viewing, analyzing and interacting with biomedical imaging data
- Slicer is **multi-platform** and runs on Windows, Linux, and Mac OS.



A multi-institutional effort



About the NAC
• Overview
• Organization
• Research Cores
• Collaborations

Resources
• Our Publications
• Downloads
• Training
• Web Archive
• Contact Us

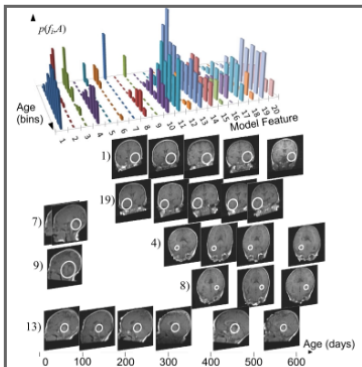

A Feature-based Developmental Model of the Infant Brain in Structural MRI
 Top: distribution $p(f, A)$ for the 20 most significant age-related features over 10 age categories. Below: visual examples of features (white circles) in subject image slices over age. Pairs (4, 8) and (1, 19) represent symmetric white matter patterns appearing at slightly different onsets. (7) and (9) represent distinct modes cerebellar atrophy linked with vermian development and occurring exclusively in early life. (13) occurs in the brain stem across the age range, more frequently in early life. Note the lack of visible white matter under 100 days, e.g. corpus callosum.

The Neuroimage Analysis Center (NAC) develops image processing and analysis techniques for basic and clinical neurosciences. The NAC research approach emphasizes both specific core technologies and collaborative application projects. The activities of the NAC are centered at the Harvard Medical School and the Surgical Planning Laboratory at the Brigham and Women's Hospital in Boston, with collaborators throughout the United States and the rest of the world.

The NAC is a Biomedical Technology Resource Center supported by the National Institute of Biomedical Imaging and Bioengineering (NIBIB) (P41 E5015902). It was supported by the National Center for Research Resources (NCRR) (P41 RR13218) through December 2011.



National Center for Image Guided Therapy

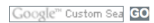

NCIGT Wiki

About Us

- ▶ Research
- ▶ Research Labs
- ▶ Collaborations
- ▶ People

Resources

- ▶ AMIGO
- ▶ Our Publications
- ▶ Downloads
- ▶ Training & Dissemination
- ▶ IGT Workshop Series
- ▶ News and Events
- ▶ Contact Us

Advanced Multimodality Image Guided Operating (AMIGO) Suite

The Advanced Multimodal Image-Guided Operating (AMIGO) suite is a clinical translational test-bed for research of the National Center for Image-Guided Therapy (NCIGT) at Brigham and Women's Hospital (BWH) and Harvard Medical School. NCIGT and AMIGO are funded under the Biomedical Technology Resource Centers program of the National Institute of Biomedical Imaging and Bioengineering. A unique resource for Image-Guided therapy, AMIGO represents and encourages multidisciplinary cooperation and collaboration among teams of surgeons, interventional radiologists, imaging physicists, computer scientists, biomedical engineers, nurses, and technologists to achieve the common goal of delivering the safest and the most effective state-of-the-art therapy to patients in a technologically advanced and patient-friendly environment. If you are a patient and would like to learn about the offerings of AMIGO, please visit the BWH AMIGO page here.





3D Slicer

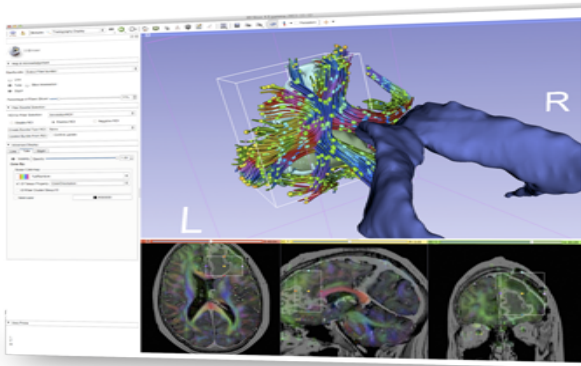

- Slicer is distributed under a **BSD-style** license agreement with no restriction on use
- Slicer is not FDA-approved nor CE-marked, and is for clinical research use only



3D Slicer



3D Slicer workshop, PLA General Hospital, Beijing

3D Slicer can be used by clinical researchers on their own Mac, Windows or Linux laptops with their own data



Slicer is built every night

Slicer4													
Dashboard	Calendar	Previous	Current	Project									
WARNING: This CDash instance is running the bleeding edge svn trunk CDash code, and is updated frequently. You have been warned.													
2 files changed by 1 author as of Friday, April 27 2012 - 23:00 EDT													
Show Filters Advanced View Auto-refresh Help													
Nightly-Packages													
Site	Build Name	Update			Configure			Build		Test			Build Time
		Files	Error	Warn	Error	Warn	Not_Run	Fail	Pass				
factory-win7.kitware	Windows7-VS2008-64bits-QT4.7.4-PythonQt-With-Tcl-CLI-Release 🚩	2	0	0	0	391 ⁺¹⁹ ₋₁₉	0	0	556		3 hours ago		
factory-win7.kitware	Windows7-VS2008-32bits-QT4.7.4-PythonQt-With-Tcl-CLI-Release 🚩	2	0	0	0	289 ⁺²⁴ ₋₂₄	0	0	556		5 hours ago		
factory-ubuntu-64bits.kitware	Linux-g++4.4.3-64bits-QT4.7.4-PythonQt-With-Tcl-CLI-Release 🚩	2	0	0	0	18 ⁺² ₋₂	0	0	558 ⁺²		6 hours ago		
factory-mac-64bits.kitware	SnowLeopard-g++4.2.1-64bits-QT4.7.4-PythonQt-With-Tcl-CLI-Release 🚩	2	0	0	0	18 ⁺⁴ ₋₄	0	0	558		5 hours ago		
Nightly													
Site	Build Name	Update			Configure			Build		Test			Build Time
		Files	Error	Warn	Error	Warn	Not_Run	Fail	Pass				
District9.kitware	Windows-VS2008-QT4.7.4-PythonQt-With-Tcl-CLI-Release	0	0	0	0	291 ⁺¹⁹ ₋₁₉	0	0	555		6 hours ago		
factory-ubuntu-64bits.kitware	Linux-g++4.4.3-64bits-QT4.7.4-PythonQt-With-Tcl-NoCLI-Coverage-Release ⚠️	0	0	0	0	17 ⁺² ₋₂	0	0	356		4 hours ago		
Extensions-Nightly													
Site	Build Name	Update			Configure			Build		Test			Build Time
		Files	Error	Warn	Error	Warn	Not_Run	Fail	Pass				
factory.kitwarein.com	🍏 19951-LoadableExtensionTemplate-g++64bits-Qt4.7-Release 🚩		0	0	0	20	0	0	2		3 hours ago		
factory.kitwarein.com	🍏 19951-SuperBuildLoadableExtensionTemplate-g++64bits-Qt4.7-Release 🚩		0	0	0	20	0	0	2		3 hours ago		
factory-ubuntu	🍏 19951-CLIEExtensionTemplate-g++64bits-Qt4.7-Release 🚩		0	0	0	0	0	0	1		5 hours ago		
factory.kitwarein.com	🍏 19951-CLIEExtensionTemplate-g++64bits-Qt4.7-Release 🚩		0	0	0	0	0	0	1		3 hours ago		
FACTORY-WIN7	🍏 19951-CLIEExtensionTemplate-vs9-32bits-Qt4.7-Release 🚩		0	0	0	0	0	0	1		3 hours ago		
FACTORY-WIN7	🍏 19951-CLIEExtensionTemplate-vs9-64bits-Qt4.7-Release 🚩		0	0	0	0	0	0	1		2 hours ago		
factory-ubuntu	🍏 19951-LoadableExtensionTemplate-g++64bits-Qt4.7-Release 🚩		0	0	0	0	0	0	2		5 hours ago		
FACTORY-WIN7	🍏 19951-LoadableExtensionTemplate-vs9-32bits-Qt4.7-Release 🚩		0	0	0	0	0	0	2		3 hours ago		

Slicer is under active development: the software is built every night on every platform



An interdisciplinary platform



An **open-source environment** for software developers



An **end-user application** for clinical investigators and scientists

A software platform that is both **easy to use** for clinical researchers and **easy to extend** for programmers



3D Slicer Training



- Training effort to transfer scientific advances in medical image computing to clinical researchers
- Courses tailored for clinicians and scientists at national events, invited seminars, and international conferences
- +3,500 trainees worldwide



Core Functionalities

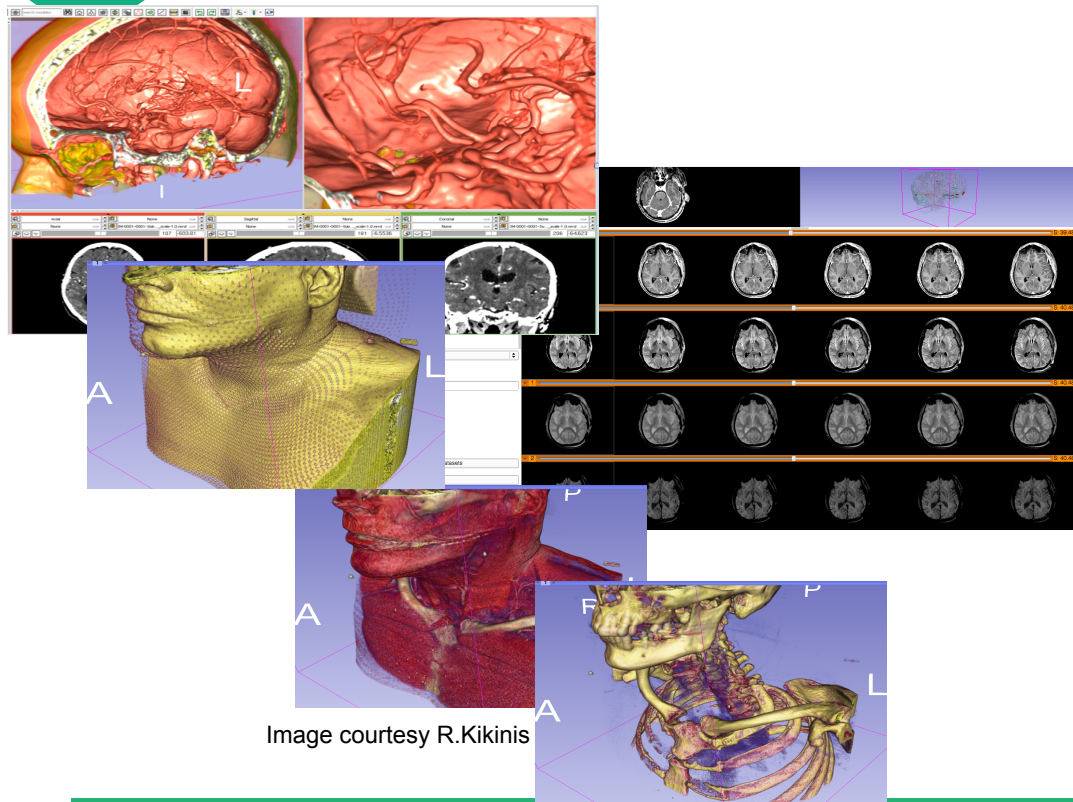
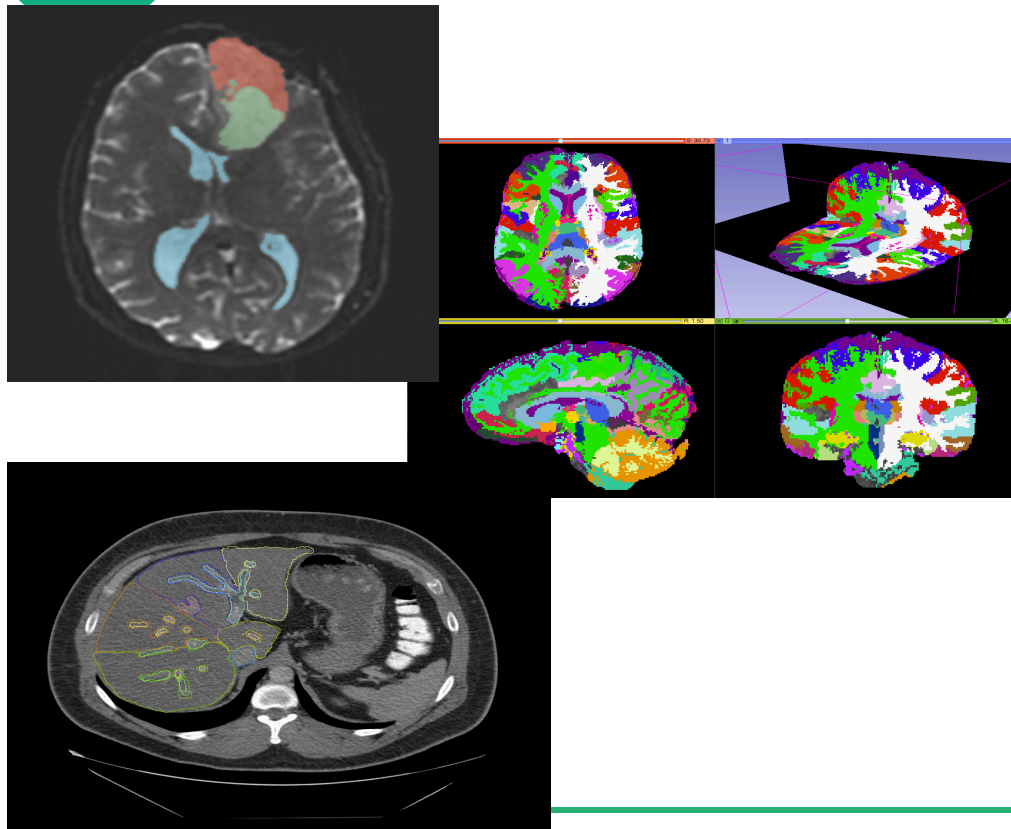

Image courtesy R.Kikinis

- Visualization
- Segmentation
- Registration
- Reconstruction
- Diffusion MRI
- Image Guided Therapy
- Quantification



Core Functionalities



- Visualization
- Segmentation
- Registration
- Reconstruction
- Diffusion MRI
- Image Guided Therapy
- Quantification



Core Functionalities



- Visualization
- Segmentation
- **Registration**
- Reconstruction
- Diffusion MRI
- Image Guided Therapy
- Quantification

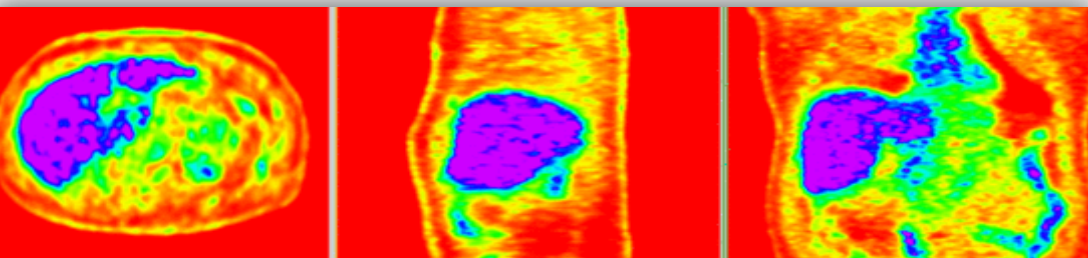



Core Functionalities

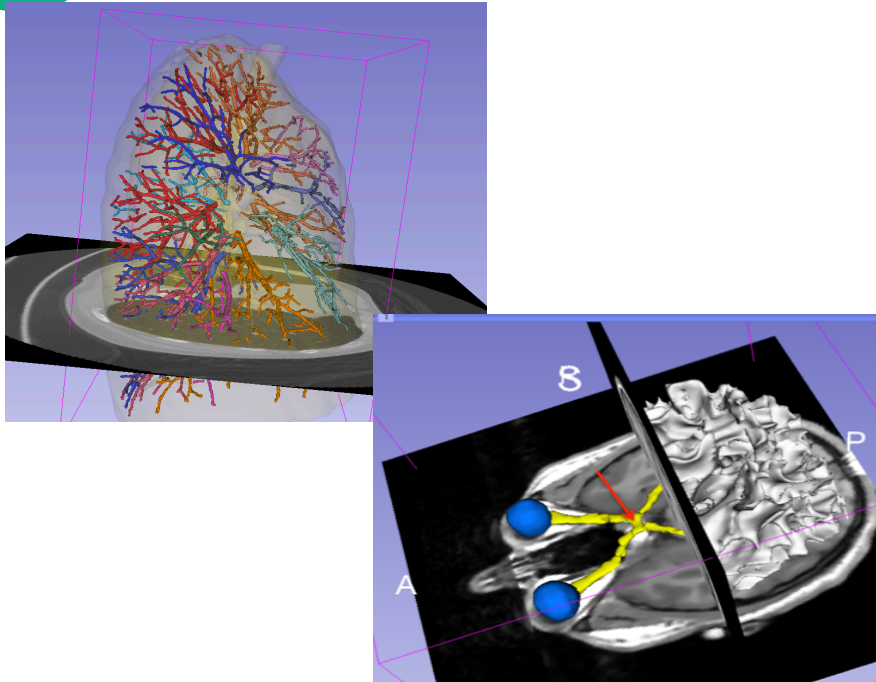

- Visualization
- Segmentation
- Registration
- **Reconstruction**
- Diffusion MRI
- Image Guided Therapy
- Quantification



Core Functionalities

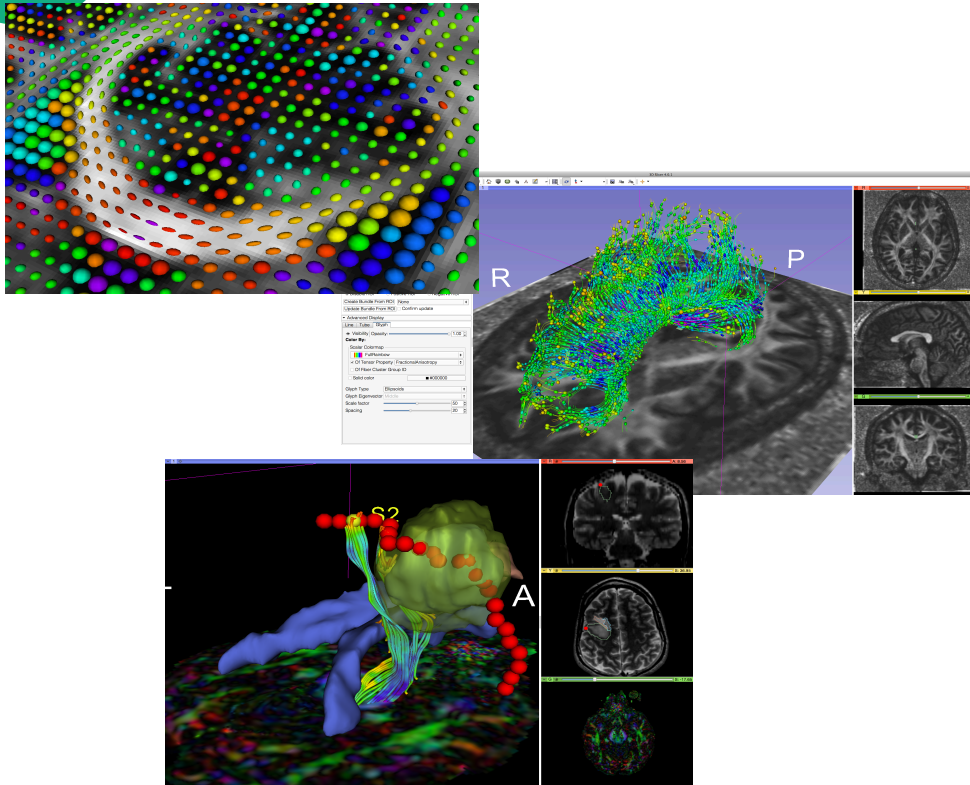

- Visualization
- Segmentation
- Registration
- Reconstruction
- **Diffusion MRI**
- Image Guided Therapy
- Quantification



Core Functionalities

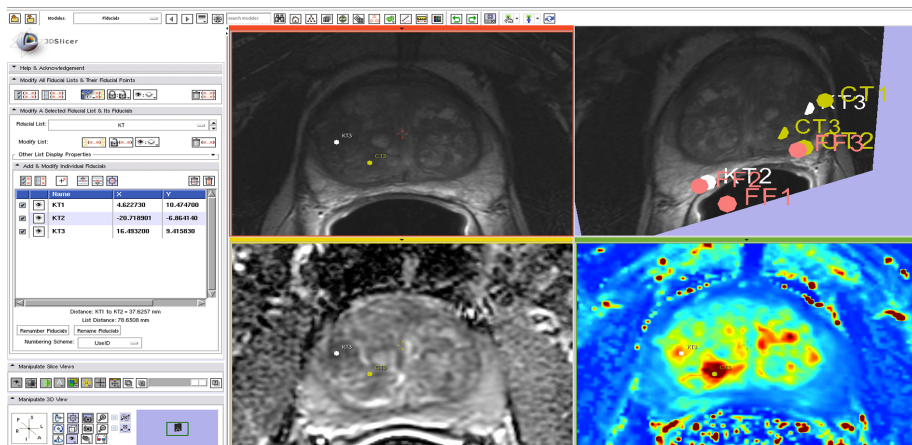

Image Courtesy A.Fedorov, T.Penzkofer, R.Kikinis

- Visualization
- Segmentation
- Registration
- Reconstruction
- Diffusion MRI
- Image Guided Therapy
- Quantification



Core Functionalities

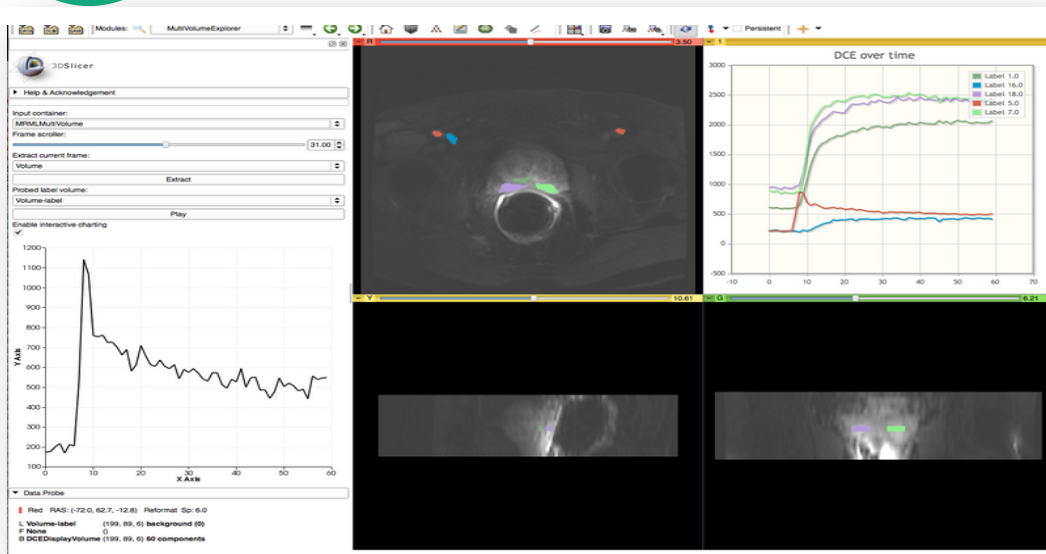
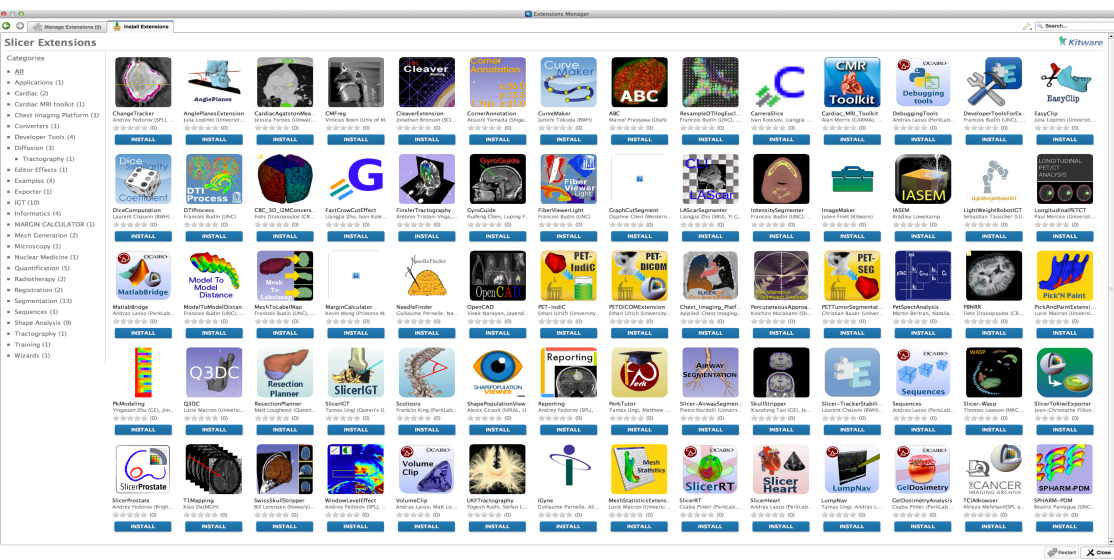

Image Courtesy A.Fedorov, R.Kikinis

- Visualization
- Segmentation
- Registration
- Reconstruction
- Diffusion MRI
- Image Guided Therapy
- Quantification



Slicer is Extensible



- Slicer is extensible through plugins called **Slicer extensions**
- The **Slicer Extension Manager** enables users to download additional Slicer modules

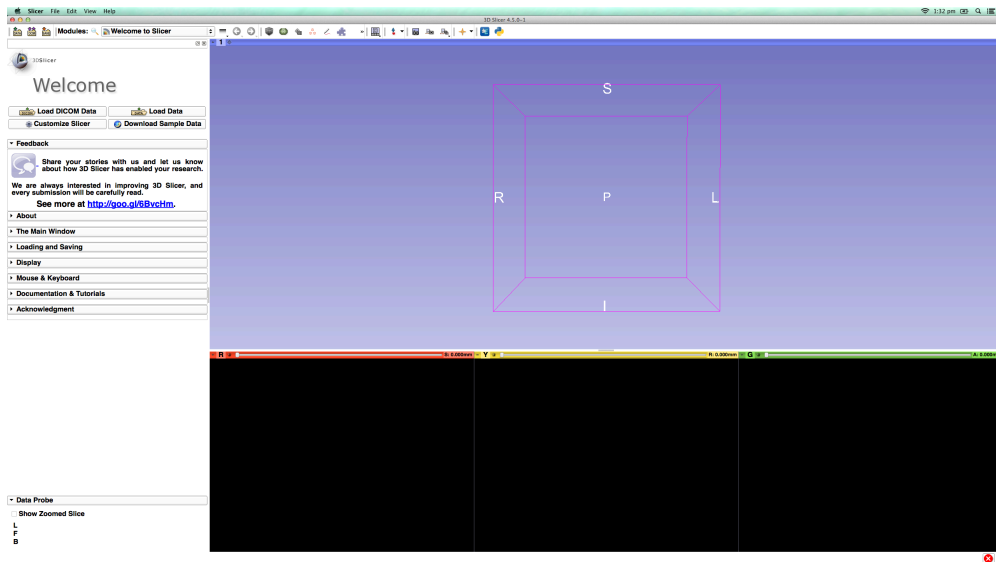

Getting Started with Slicer 4.5



Welcome to Slicer 4.5

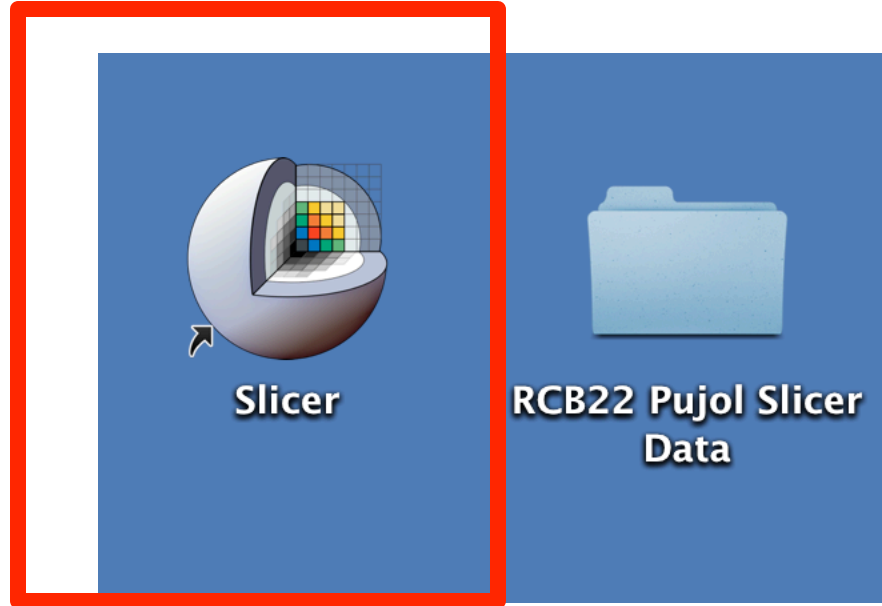

To start Slicer, double-click on the Slicer icon on the Desktop



Welcome to Slicer 4.5

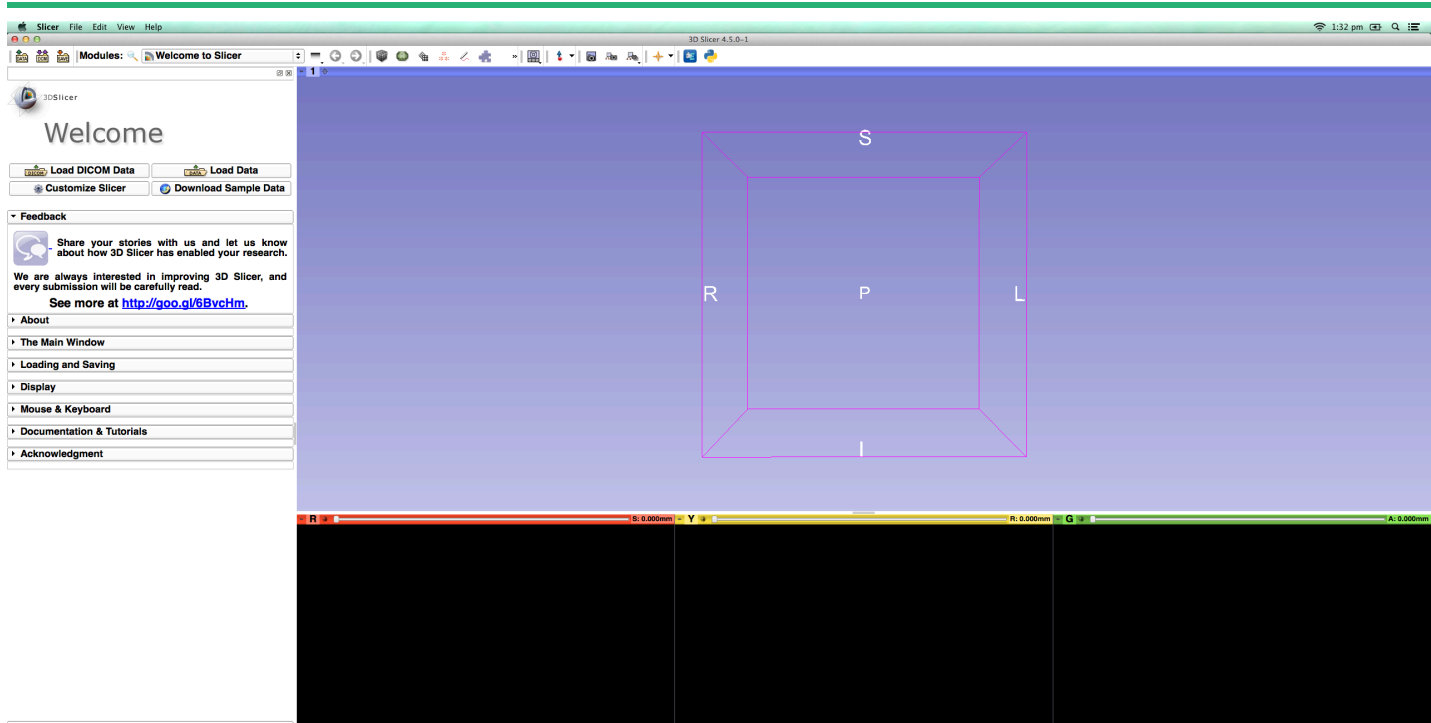

To start Slicer, double-click on the Slicer icon on the Desktop



Navigating the Application GUI

The Graphic User Interface (GUI) of Slicer4 integrates **four components**:

- the Menu Toolbar
- the Module GUI Panel
- the 3D Viewer
- the Slice Viewer

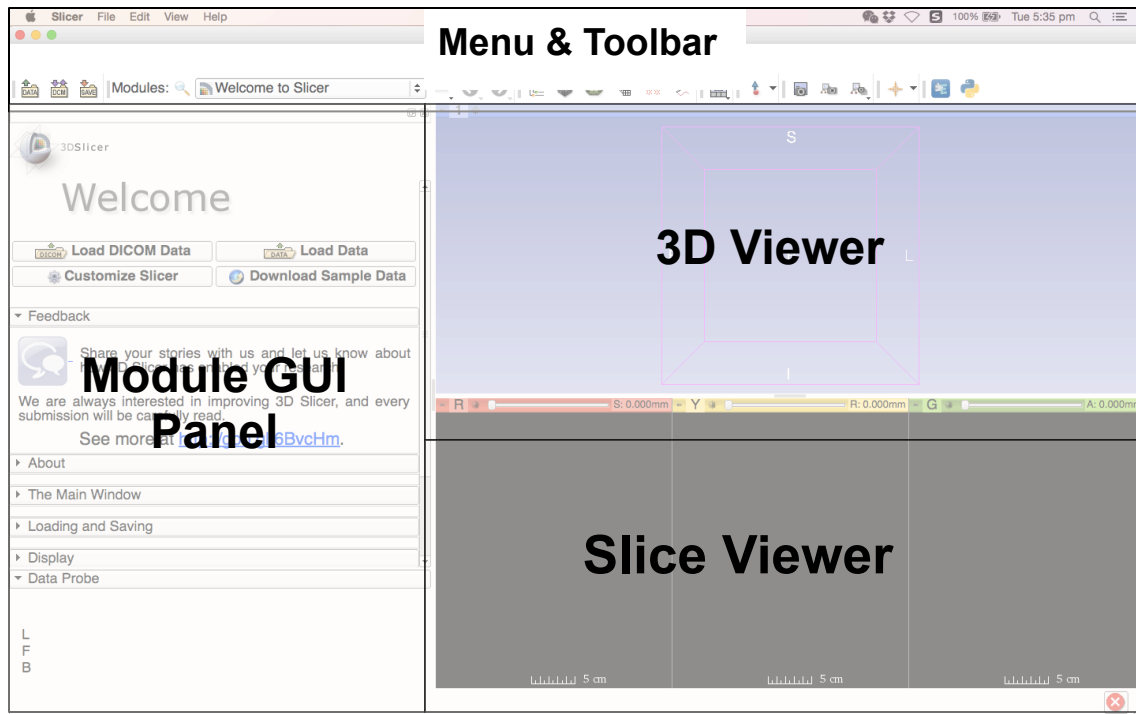



Slicer Modules

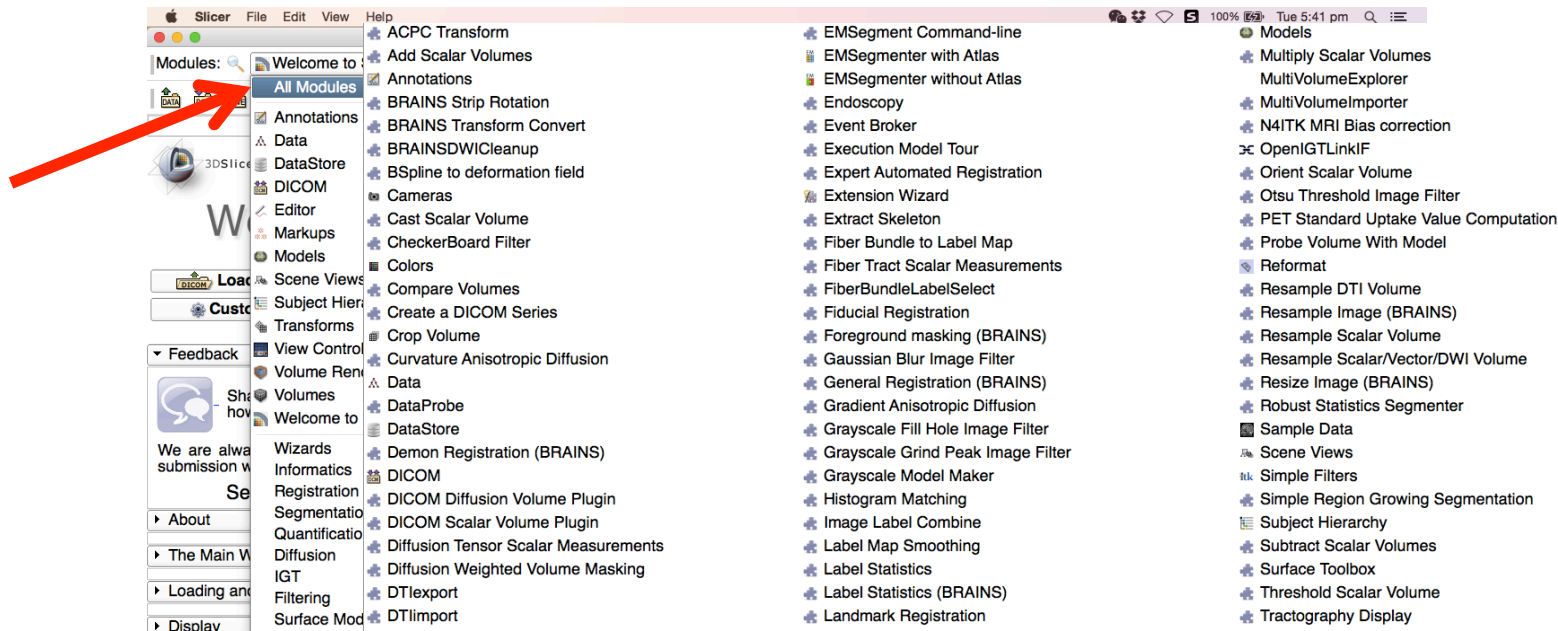

Click on **Welcome to Slicer** and select **All Modules** to display the list of Slicer modules



Slicer Modules

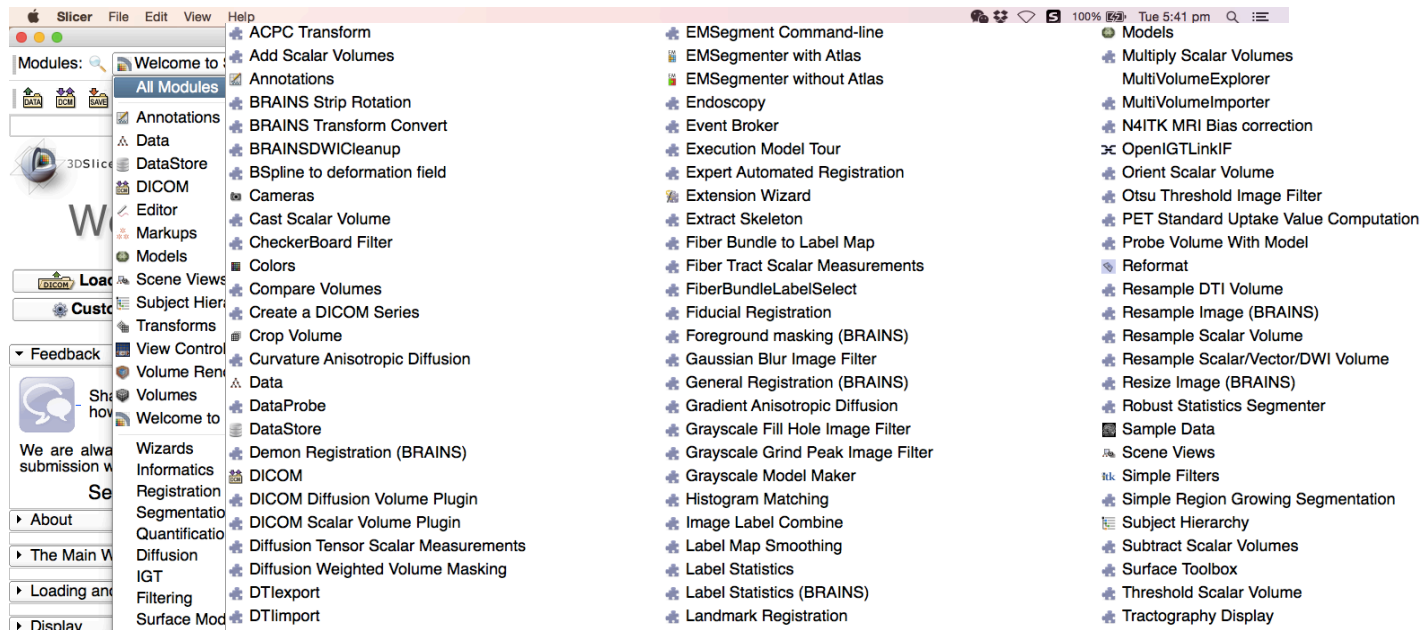

Slicer version 4.5 contains over 100 modules for segmentation, registration and 3D visualization of medical image data



Course Overview

Part I: Introduction to the 3D Slicer software

Part II: 3D Data Loading and visualization of DICOM images

Volume Rendering of thoraco-abdominal CT data

Surface Rendering of MR head data

Part III: 3D interactive exploration of the anatomy

Interactive Exploration of the Segments of the liver

Interactive Exploration of the Segments of the lung



Tutorial Datasets

In this tutorial, we will use four different datasets:



Tutorial Datasets

In this tutorial, we will use four different datasets:

- **Dataset 1: Thorax & Abdomen**

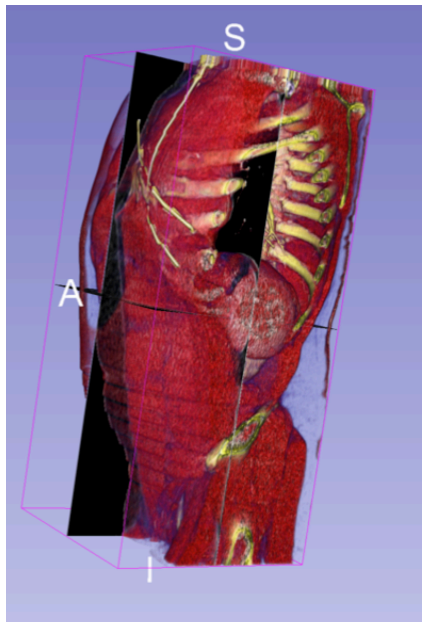



Tutorial Datasets

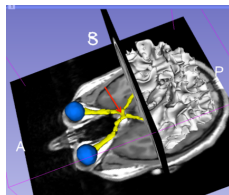
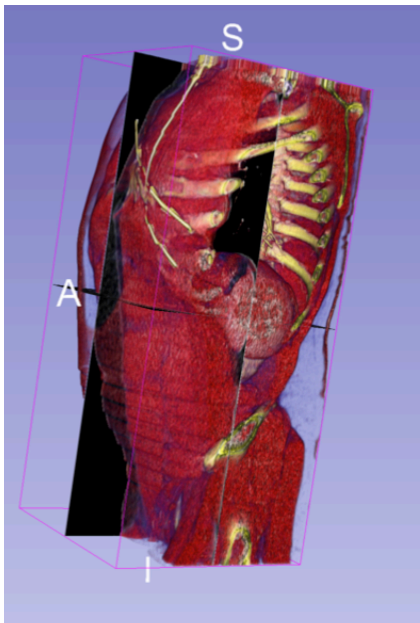

In this tutorial, we will use four different datasets:

- **Dataset 1:** Thorax & Abdomen
- **Dataset 2:** Head



Tutorial Datasets

In this tutorial, we will use four different datasets:

- **Dataset 1:** Thorax & Abdomen
- **Dataset 2:** Head
- **Dataset 3:** Liver

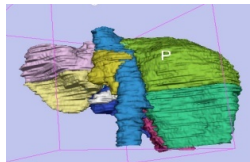
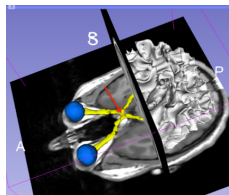
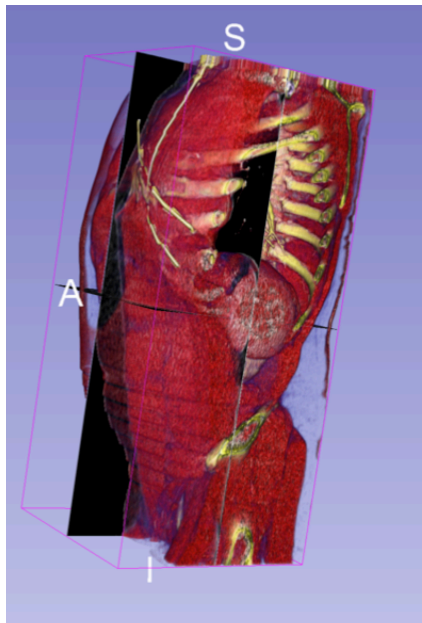



Tutorial Datasets

In this tutorial, we will use four different datasets:

- **Dataset 1:** Thorax & Abdomen
- **Dataset 2:** Head
- **Dataset 3:** Liver
- **Dataset 4:** Chest

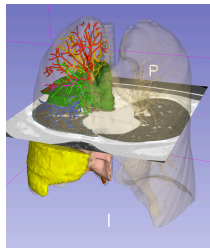
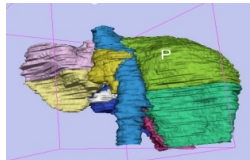
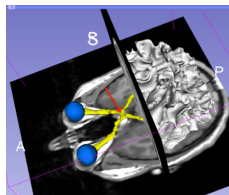
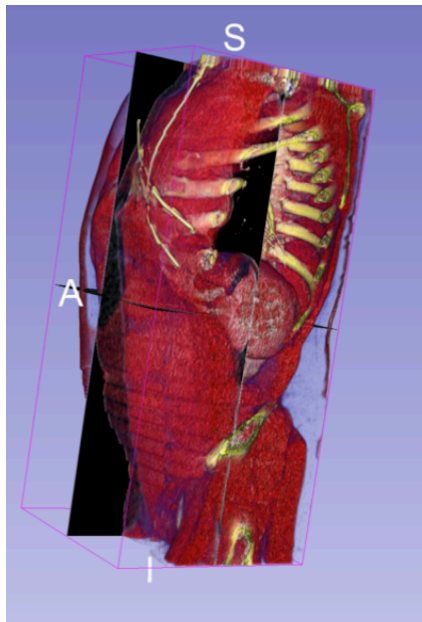



Tutorial datasets

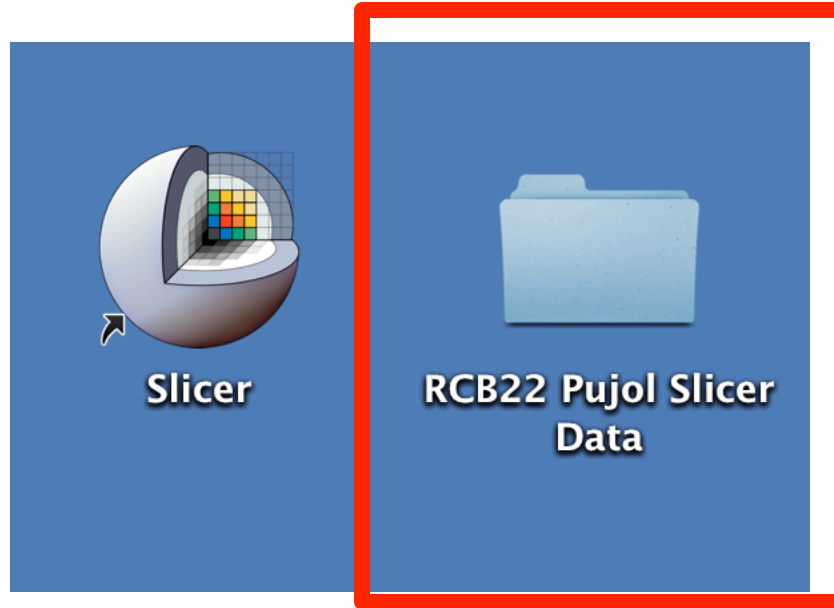

To access the datasets, double click on the directory **RCB22 Pujol Slicer Data** on the Desktop.



Tutorial datasets

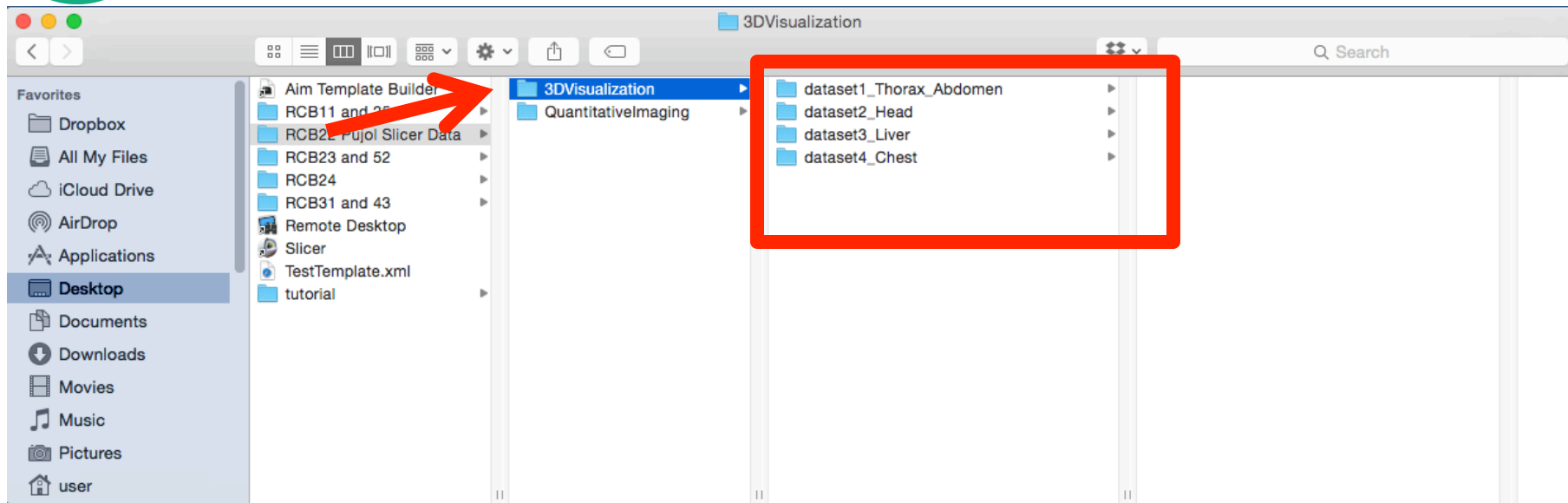

Double click on the folder **3DVisualization** to access the 4 tutorial datasets



Loading a DICOM volume

RCB22 Pujol Slicer Data

Name

- ▼ 3DVisualization
 - ▶ dataset4_Chest
 - ▶ dataset1_Thorax_Abdomen
 - ▶ dataset2_Head
 - ▶ dataset3_Liver

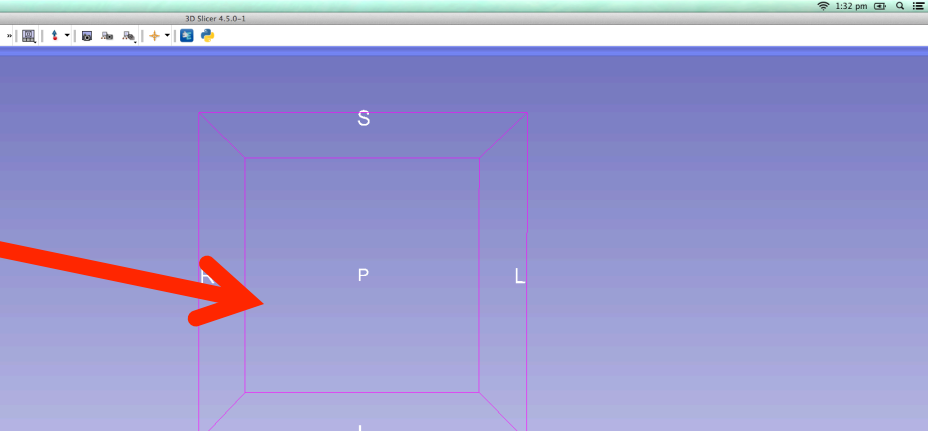

Drag and drop the directory 'dataset1_Thorax-Abdomen' into Slicer

▼ Data Probe
 Show Zoomed Slice
L
F
B



Loading a DICOM volume

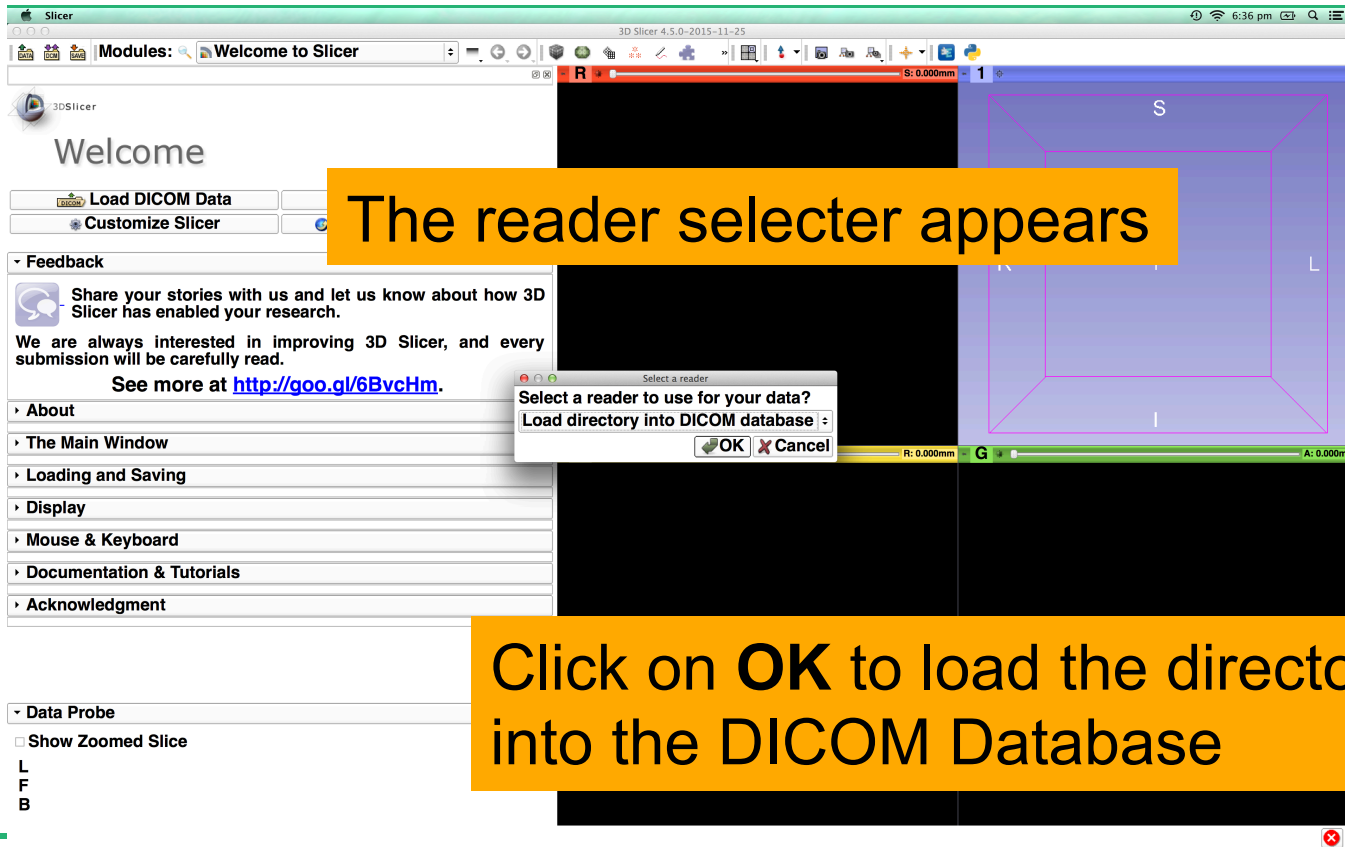



Loading a DICOM volume

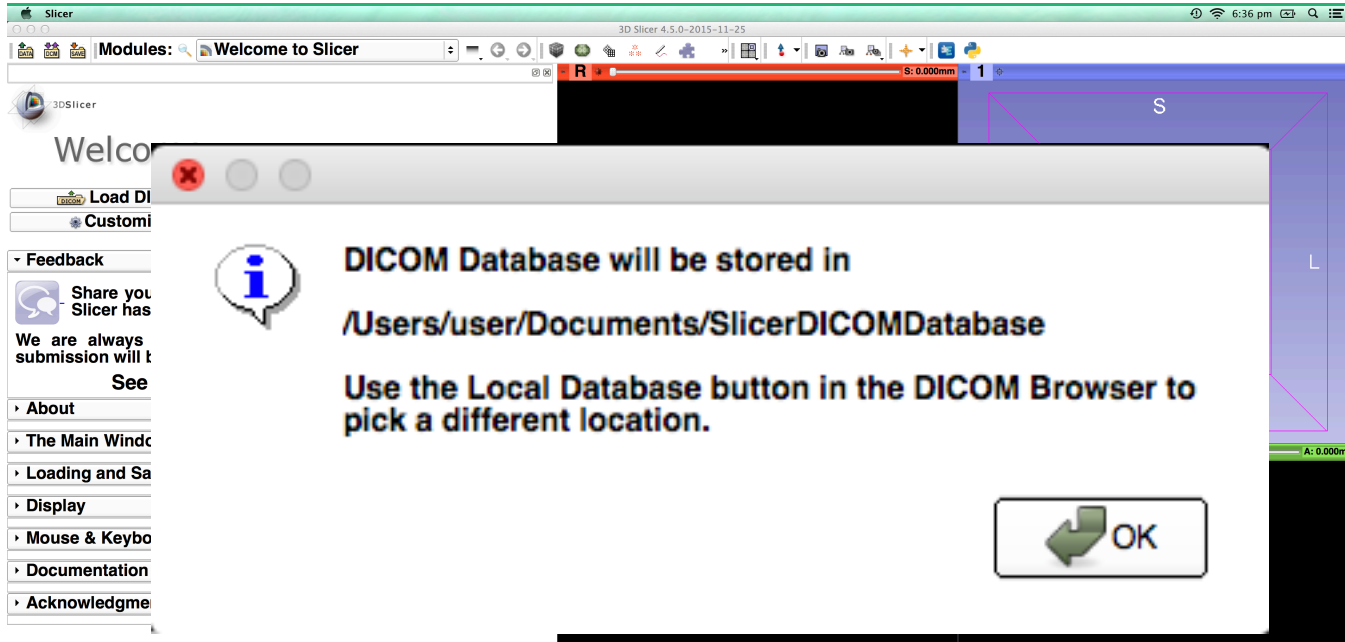

A DICOM pop-up window appears to inform the user where Slicer will store the DICOM Database
Click on **OK** to use the default DICOM Database



Loading a DICOM volume

The **DICOM Browser** window appears

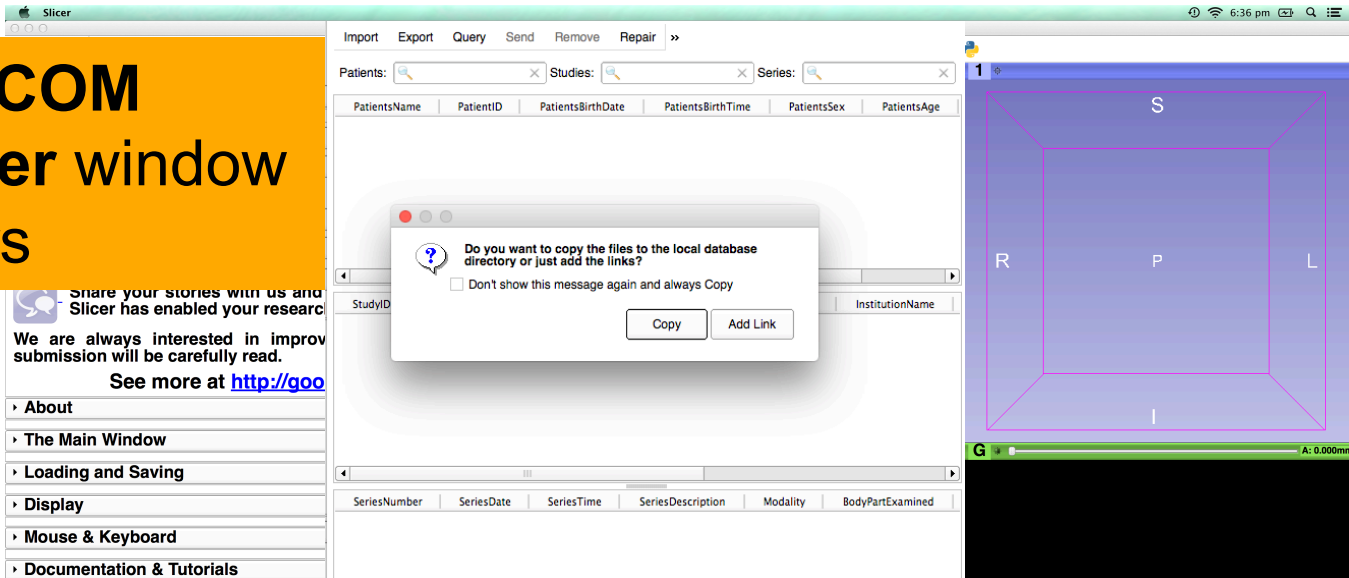

Click on **Add Link** to add a link to dataset to the local database directory

Share your stories with us and Slicer has enabled your research. We are always interested in improving submission will be carefully read. See more at <http://goo>

- ▶ About
- ▶ The Main Window
- ▶ Loading and Saving
- ▶ Display
- ▶ Mouse & Keyboard
- ▶ Documentation & Tutorials
- ▶ Acknowledgments

▼ Data Pr
 Show Z
L
F
B



Loading a DICOM volume

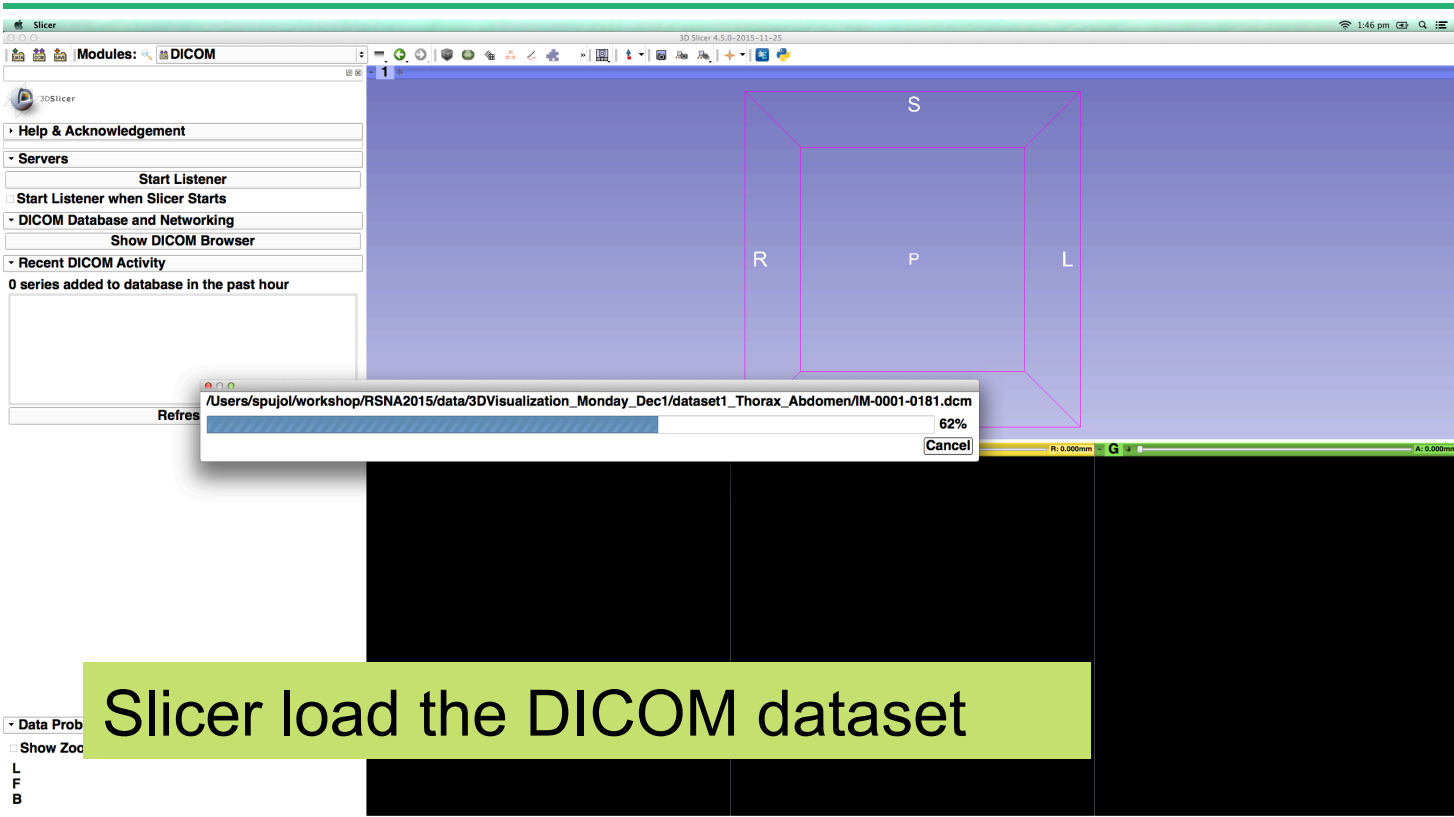

Slicer load the DICOM dataset



Loading a DICOM volume

Click on **OK** once the directory import is completed

The screenshot shows the Slicer DICOM Browser interface. A dialog box titled "Directory import completed." is displayed in the center, containing the following information:

- 1 New Patients
- 1 New Studies
- 1 New Series
- 291 New Instances

An "OK" button is located at the bottom of the dialog box, with a red arrow pointing to it. The background interface includes a sidebar with "Modules: DICOM", "Start Listener", "DICOM Database and Networking", and "Recent DICOM Activity". The main window displays a table of DICOM metadata.

PatientName	PatientID	PatientBirthDate	PatientBirthTime	PatientSex	PatientAge	PatientComments
patient1	patient1_ID					

StudyID	StudyDate	SeriesTime	SeriesDescription	Modality	BodyPartExamined	AcquisitionNumber	ContrastAgent	ScanningSequence	EchoNumber	TemporalPosition
6936864	2005-06-01	120000.000000	CT_Thorax_Abdomen	CT	HEART	14	APPLIED		0	0

At the bottom of the DICOM Browser window, there are checkboxes for "Advanced", "Horizontal", and "Browser Persistent".



Loading a DICOM volume

Select the dataset **patient1** in the DICOM Browser window and click on **Load**

The screenshot shows the 3D Slicer interface with the DICOM Browser window open. A red arrow points to the 'patient1' entry in the Patients table. A red box highlights the 'Load' button in the bottom left corner of the DICOM Browser window.

PatientsName	PatientID	PatientsBirthDate	PatientsBirthTime	PatientsSex	PatientsAge	PatientsComments
patient1	patient1_ID					

StudyID	StudyDate	StudyTime	AccessionNumber	ModalitiesStudy	InstitutionName	ReferringPhysician	PerformingPhysiciansName	StudyDescription
0316864	2005-06-01	12:00:00.000000	6938864		06722007...791610x			CT,Thorax,Abdomen

SeriesNumber	SeriesDate	SeriesTime	SeriesDescription	Modality	BodyPartExamined	AcquisitionNumber	ContrastAgent	ScanningSequence	EchoNumber	TemporalPosition
6	2005-06-01	12:00:00.000000	CT,Thorax,Abdomen	CT	HEART	14	APPLIED		0	0

Show Zoomed Slice
L
F
B

Load metadata Advanced Horizontal Browser Persistent



Loading a DICOM volume

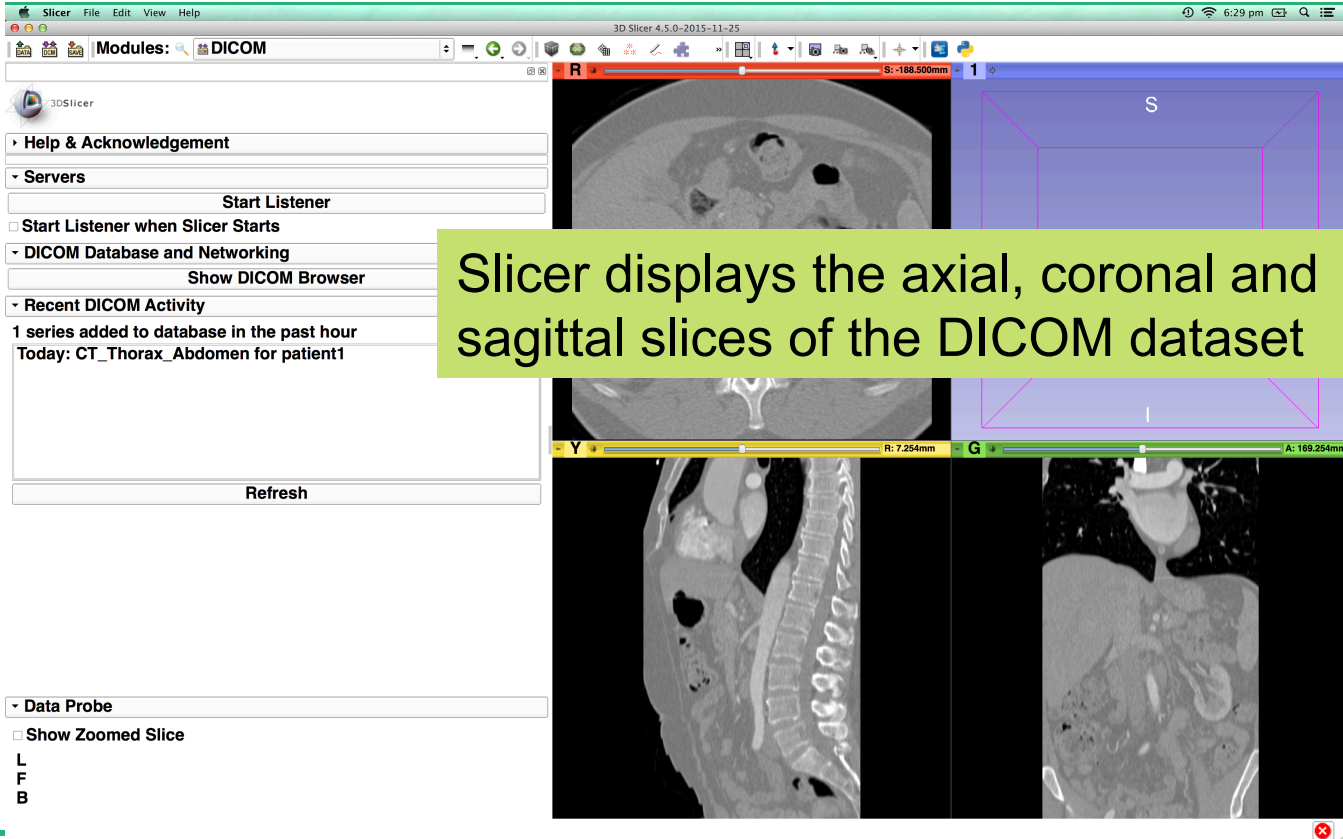



Loading a DICOM volume

Click on the display icon and select the display

Conventional

3D Slicer 4.5.0-2015-11-25

Modules: DICOM

3DSlicer

Help & Acknowledgement

Conventional

- Conventional Widescreen
- Conventional Quantitative
- Four-Up
- Four-Up Quantitative
- Dual 3D
- Triple 3D
- 3D only
- One-Up Quantitative
- Red slice only
- Yellow slice only
- Green slice only
- Tabbed 3D
- Tabbed slice
- Compare
- Compare Widescreen
- Compare Grid
- Three over three
- Three Over Three Quantitative
- Four over four
- Two over Two
- Side by side
- Four by three slice
- Four by two slice
- Three by three slice

R

Y

I

A: 169.254mm

Data Probe

Show Zoomed Slice

L

F

B



Loading a DICOM volume

The screenshot shows the Slicer software interface. On the left, the 'All Modules' list is expanded, and the 'Volumes' module is highlighted in blue. A red arrow points from the 'Volumes' module to a yellow callout box on the right. The callout box contains the text: 'Click on **DICOM** to display the list of Slicer modules, and select the module **Volumes**'. The main window displays a 3D view of a CT scan volume, with a sagittal slice visible on the left and an axial slice on the right. The status bar at the bottom shows the dimensions: 500mm (W), 7.254mm (R), and 169.254mm (A).



Loading a DICOM volume

Slicer displays the GUI of the module **Volumes**

Select the Active Volume **6:CT_Thorax_Abdomen**

Select the window level preset **CT-abdomen**



Loading a DICOM volume

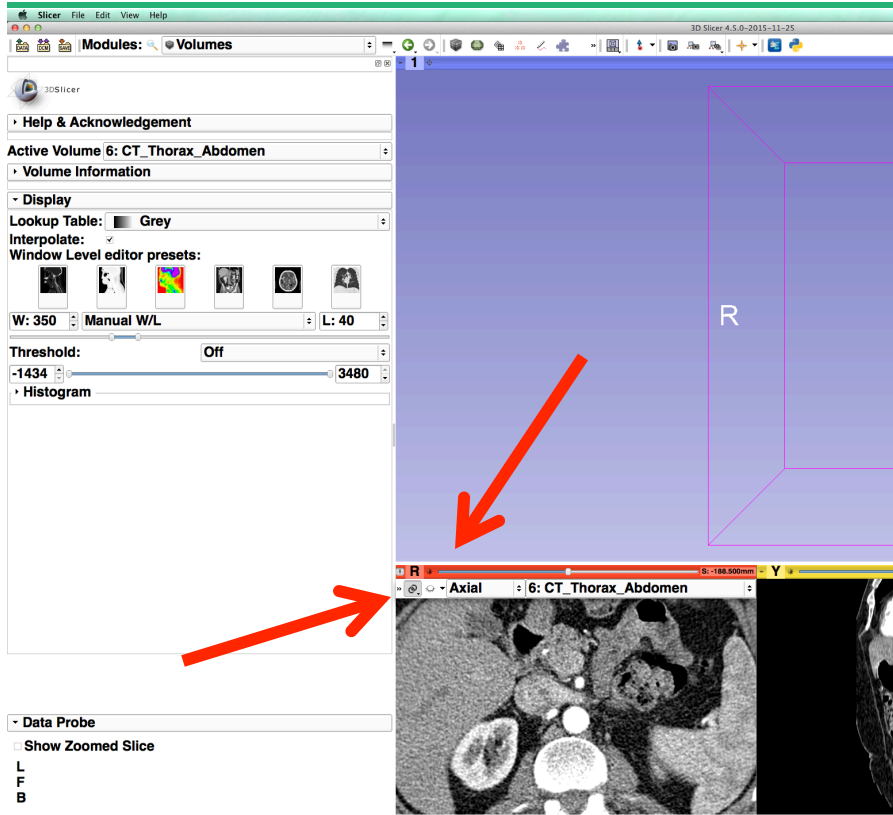

Position the mouse cursor over the banner in the Red Viewer to display the slice menu.

Click on the **Links icon**  to link the slice controls across all Slice Viewers.

Click on the **Eye icon**  to display the three anatomical slices in the 3D Viewer



Loading a DICOM volume

The three anatomical slices appear in the 3D viewer. Use the right-mouse button in the 3D Viewer to zoom in/out

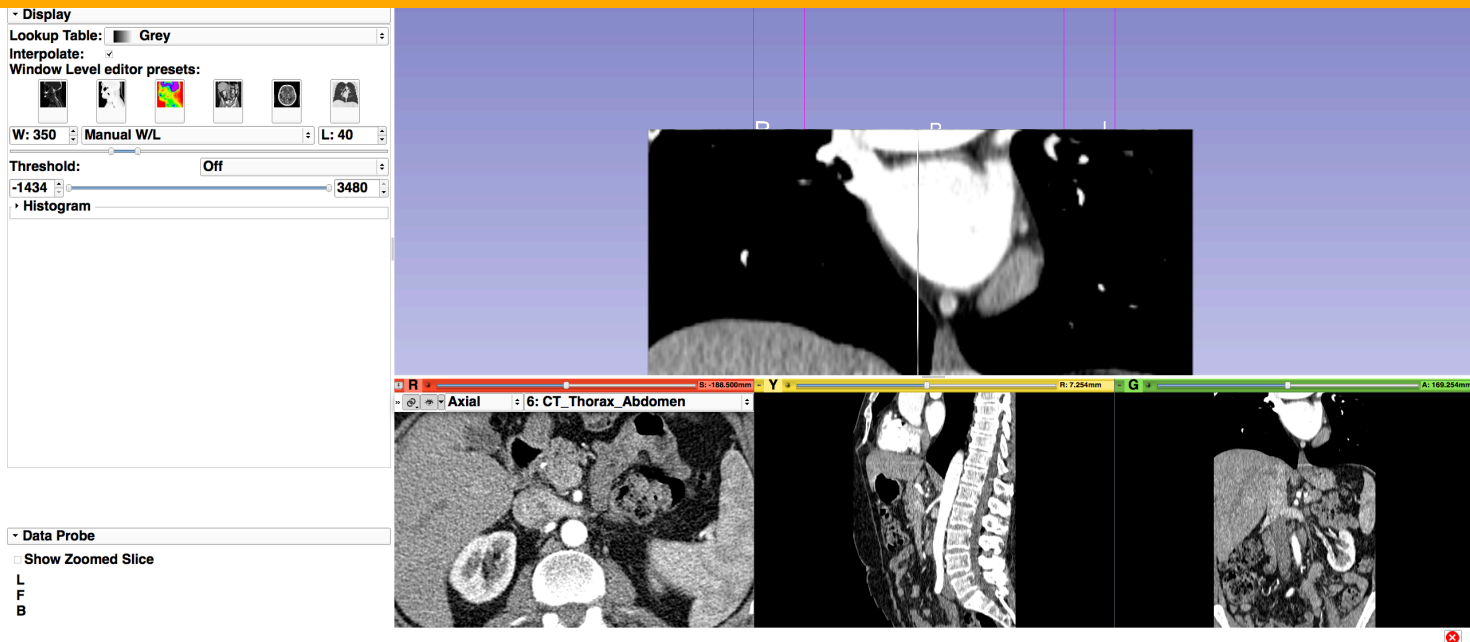



Loading a DICOM volume

Use the left-mouse button in the 3D Viewer to rotate the 3D volume

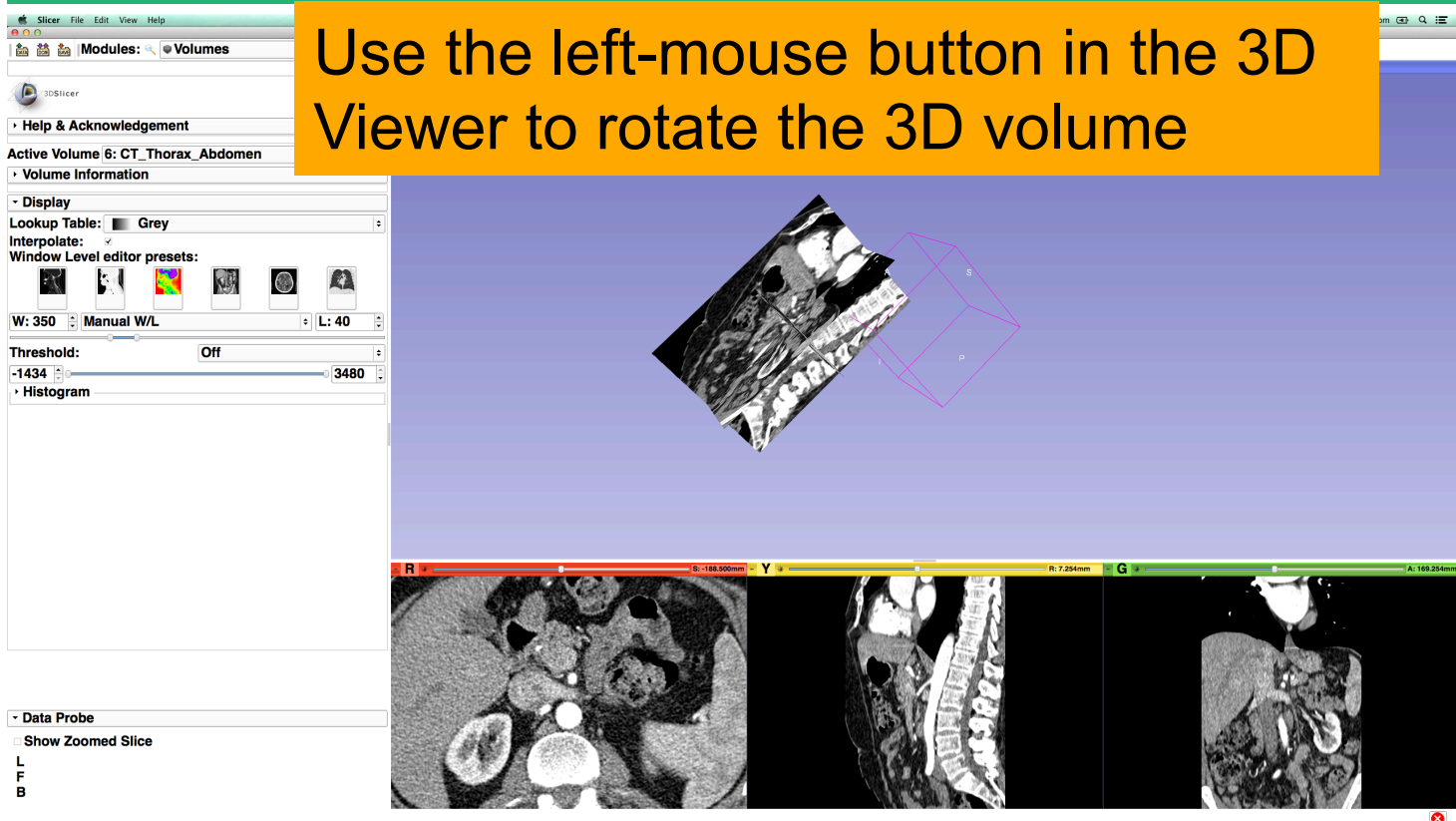



Loading a DICOM volume

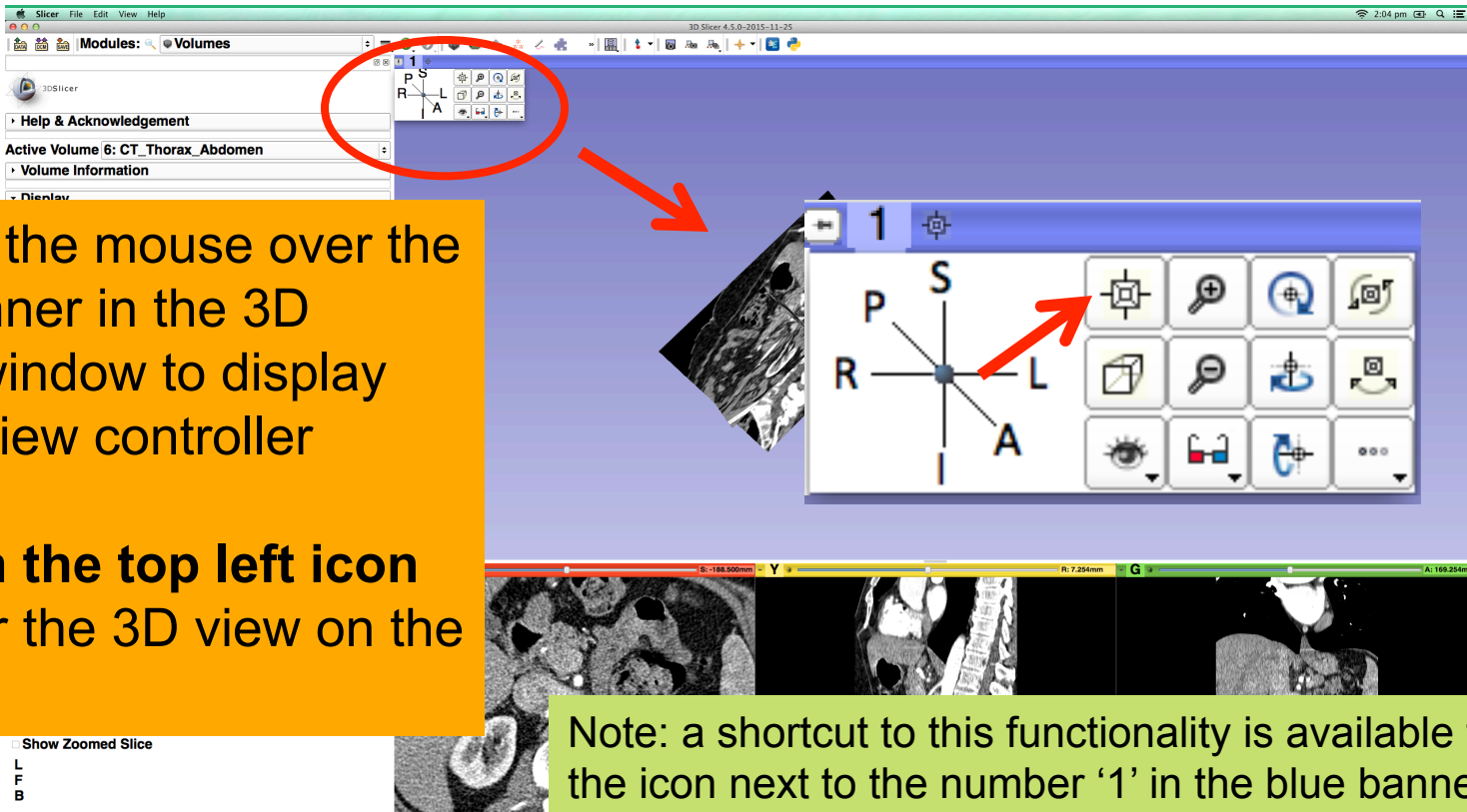

Position the mouse over the blue banner in the 3D viewer window to display the 3D view controller

Click on the top left icon to center the 3D view on the scene

Note: a shortcut to this functionality is available through the icon next to the number '1' in the blue banner



Loading a DICOM volume

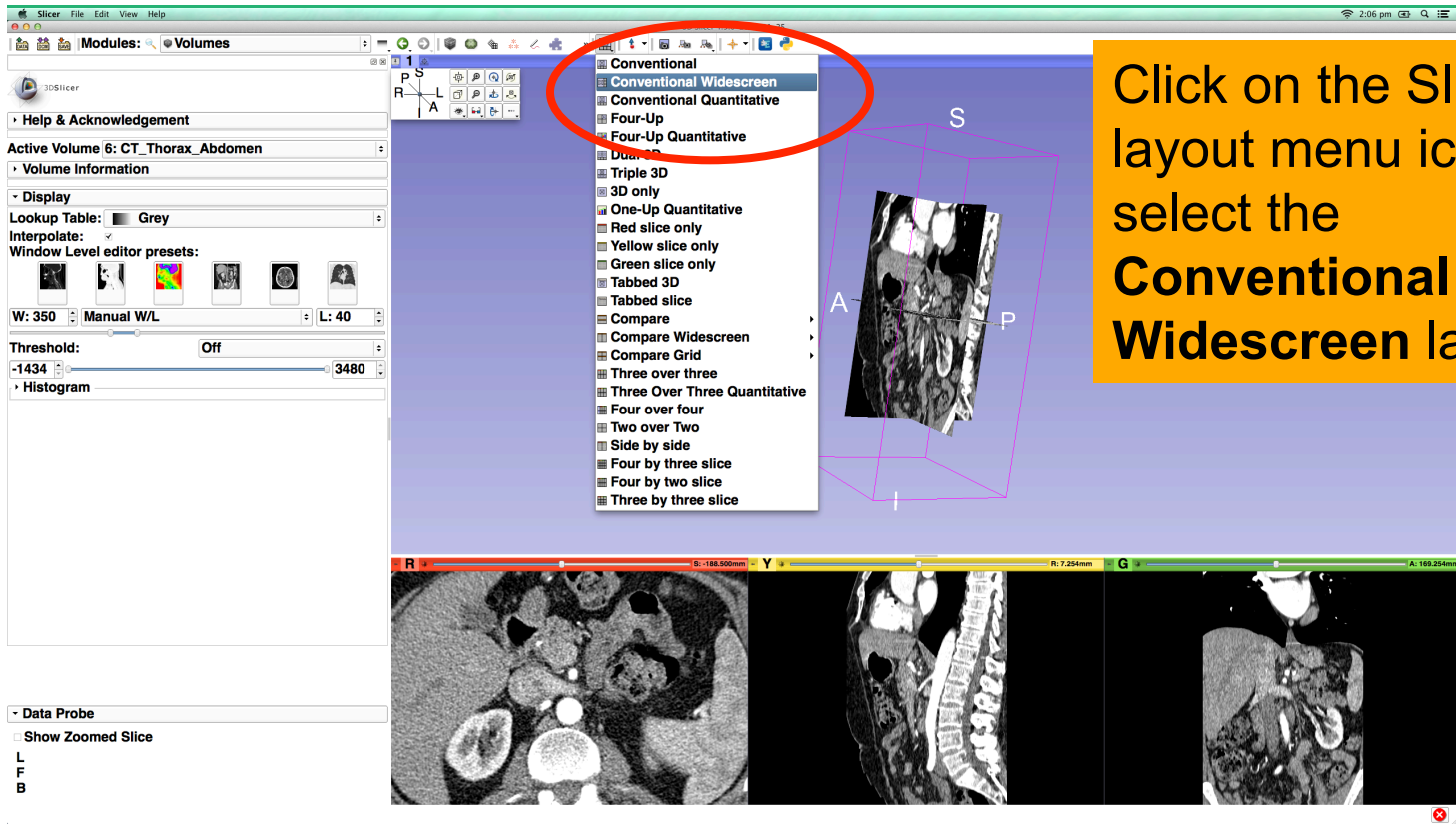

Click on the Slicer layout menu icon, and select the **Conventional Widescreen** layout



Loading a DICOM volume

Click on the square icon  next to the letter 'R' in the Red Banner to adjust the field of view of the slices to the size of the window

Interpolate:

Window Level editor presets:



W: 350 Manual W/L L: 40

Threshold: Off

-1434 3480

► Histogram

Use the red, yellow and green sliders to slice through the volume in all three anatomical directions

▼ Data Probe

Show Zoomed Slice

L
F
B



Adjust the Slice Viewer's field of view to match the extent of lowest non-None volume layer (bg, then fg, then label).

R: -158.500mm

Y: 7.254mm

G: 169.254mm



Loading a DICOM volume

Slicer displays the axial, sagittal and coronal slices of the DICOM volume in the 3D viewer.

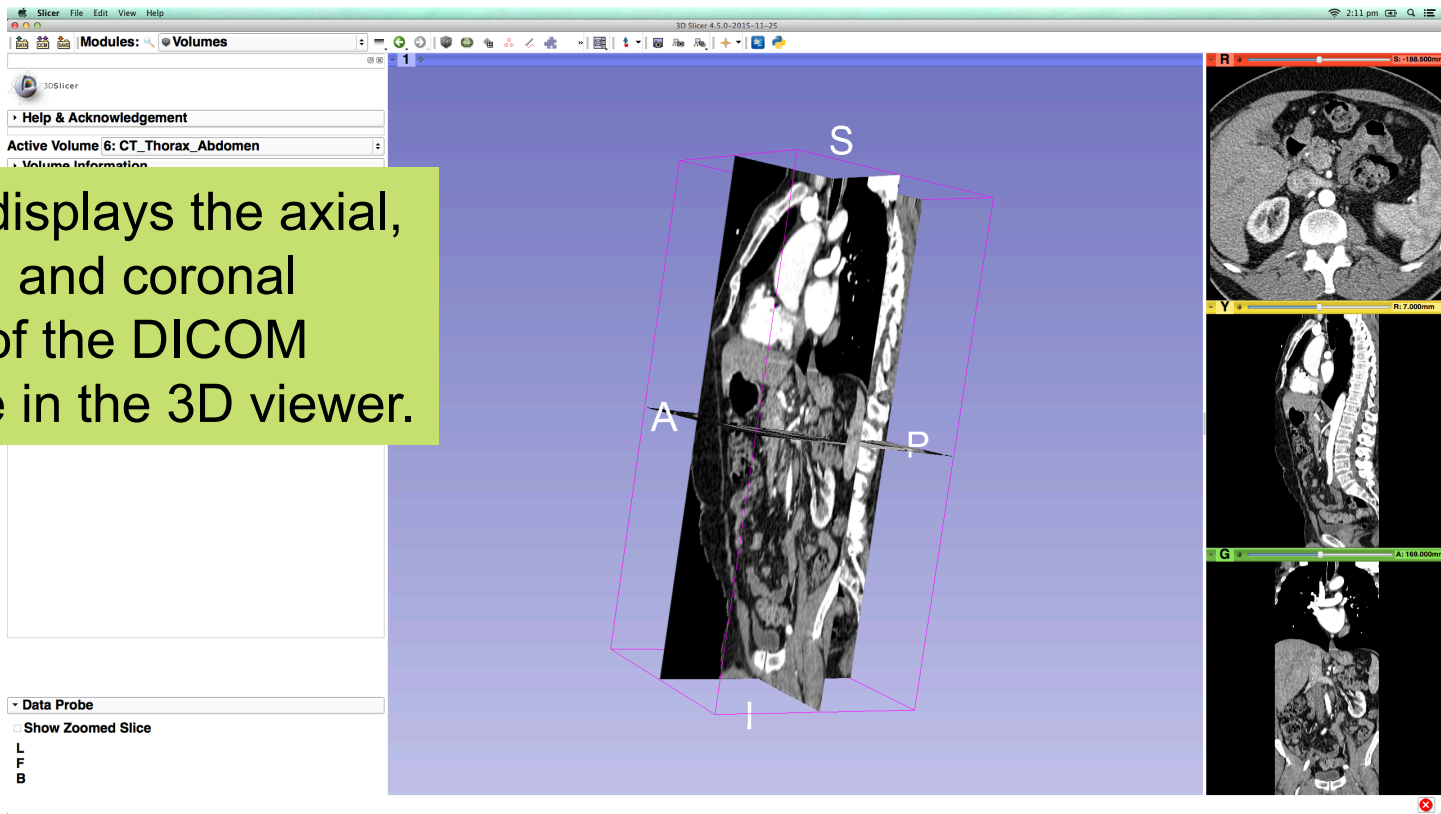



Volume Rendering

The screenshot shows the 3D Slicer software interface. The 'Modules' menu at the top left is open, and the 'Volume Rendering' module is selected, highlighted by a red arrow. A yellow callout box with black text points to this selection, stating: 'Select the module **Volume Rendering** in the modules menu'. The main 3D view displays a sagittal CT scan of a human torso with a purple wireframe bounding box and a horizontal slice line labeled 'A' and 'P'. To the right, there are three smaller viewports: a coronal slice labeled 'Y', a sagittal slice labeled 'G', and another coronal slice. The left sidebar contains various settings for the Volume Rendering module, including 'Preset: Select a Preset', 'Shift: Enable', 'Crop: Display ROI', and 'Rendering: VTK CPU Ray Casting'.



Volume Rendering

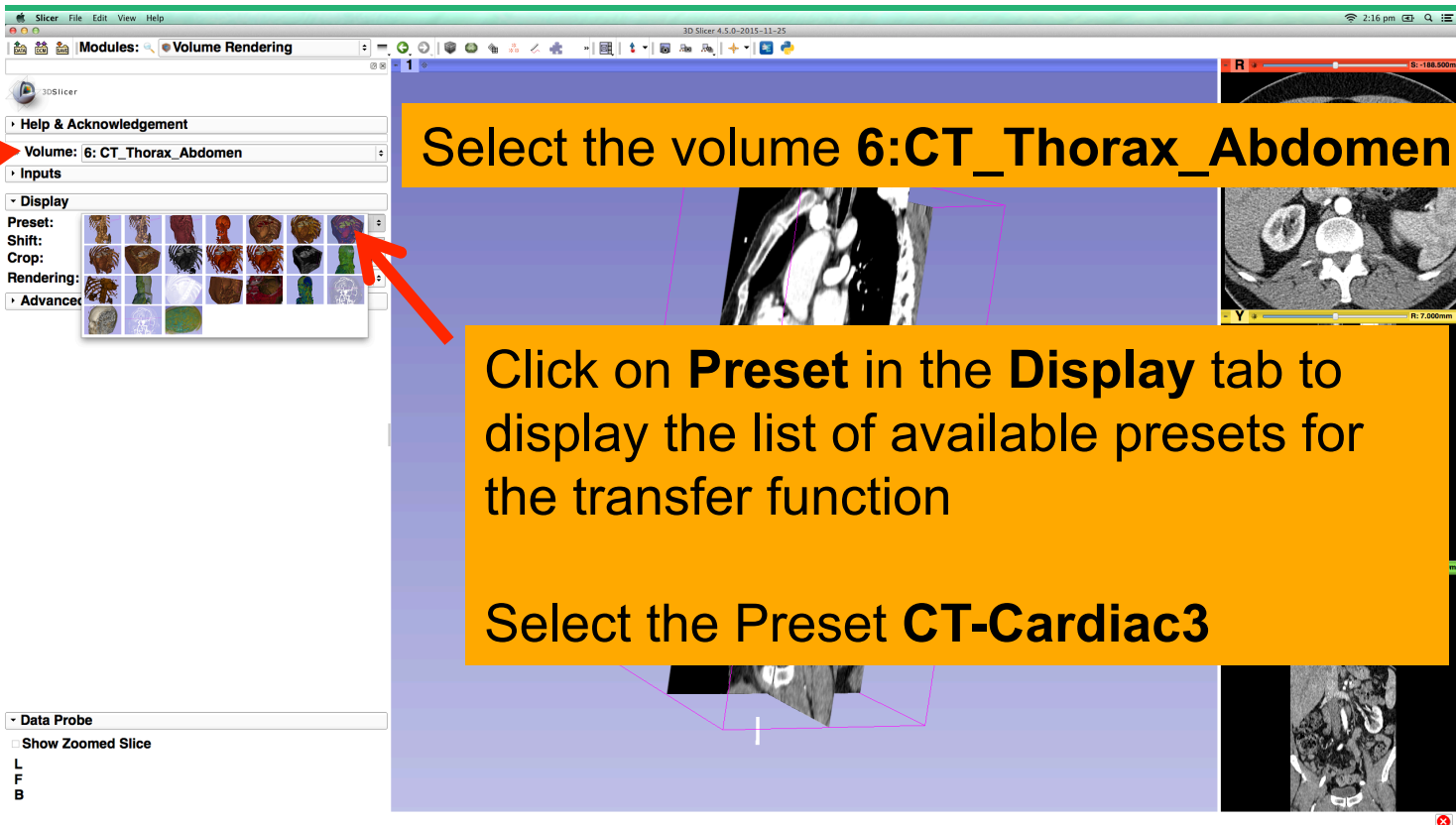



Volume Rendering

Select the Rendering **VTK GPU Ray Casting**, and click on the eye icon in the **Volume** tab to display the volume rendered volume

The image shows a screenshot of the 3D Slicer software interface. On the left, the 'Volume Rendering' module is active. The 'Display' section shows 'Preset: CT-Cardiac3', 'Crop: Enable', and 'Rendering: VTK GPU Ray Casting'. A red arrow points to the 'Advanced...' button. The main 3D view shows a sagittal CT scan of a thorax and abdomen, with a purple wireframe bounding box and a crosshair labeled 'A' and 'P'. On the right, there are two 2D slice views: a coronal slice at the top and an axial slice at the bottom, both showing the same anatomical region.



Volume Rendering

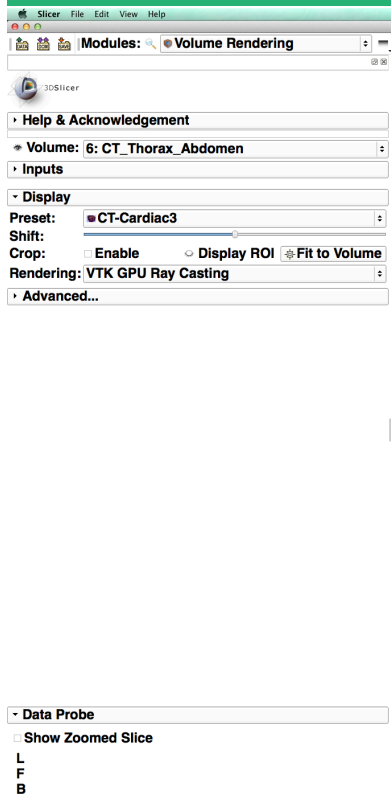

The volume rendered image of the CT Dicom dataset appears in the 3D viewer

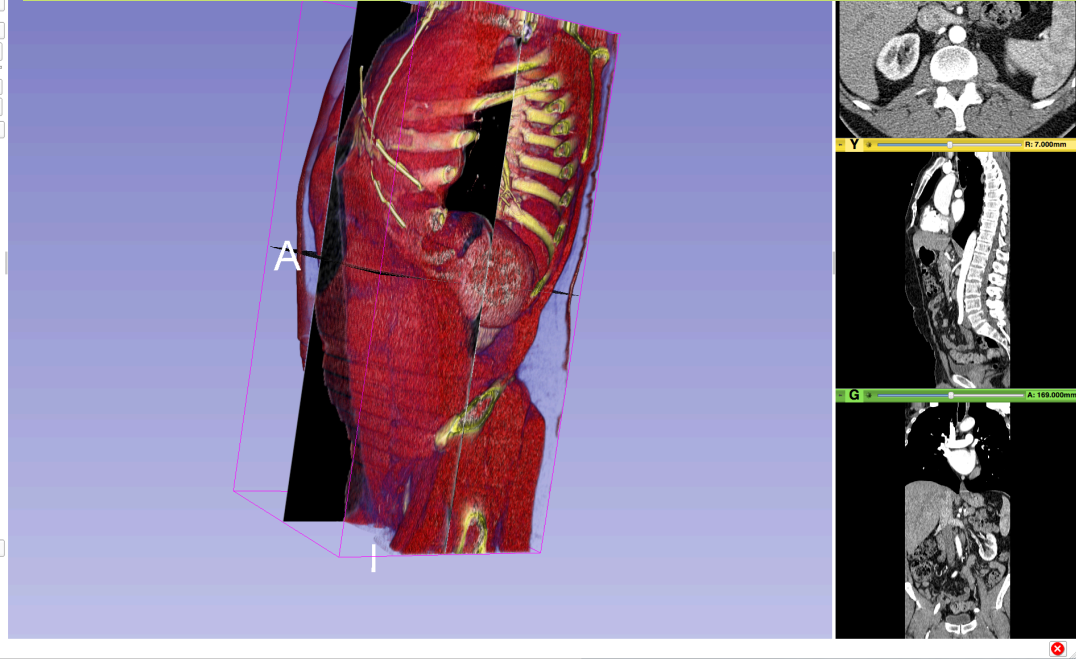



Volume Rendering

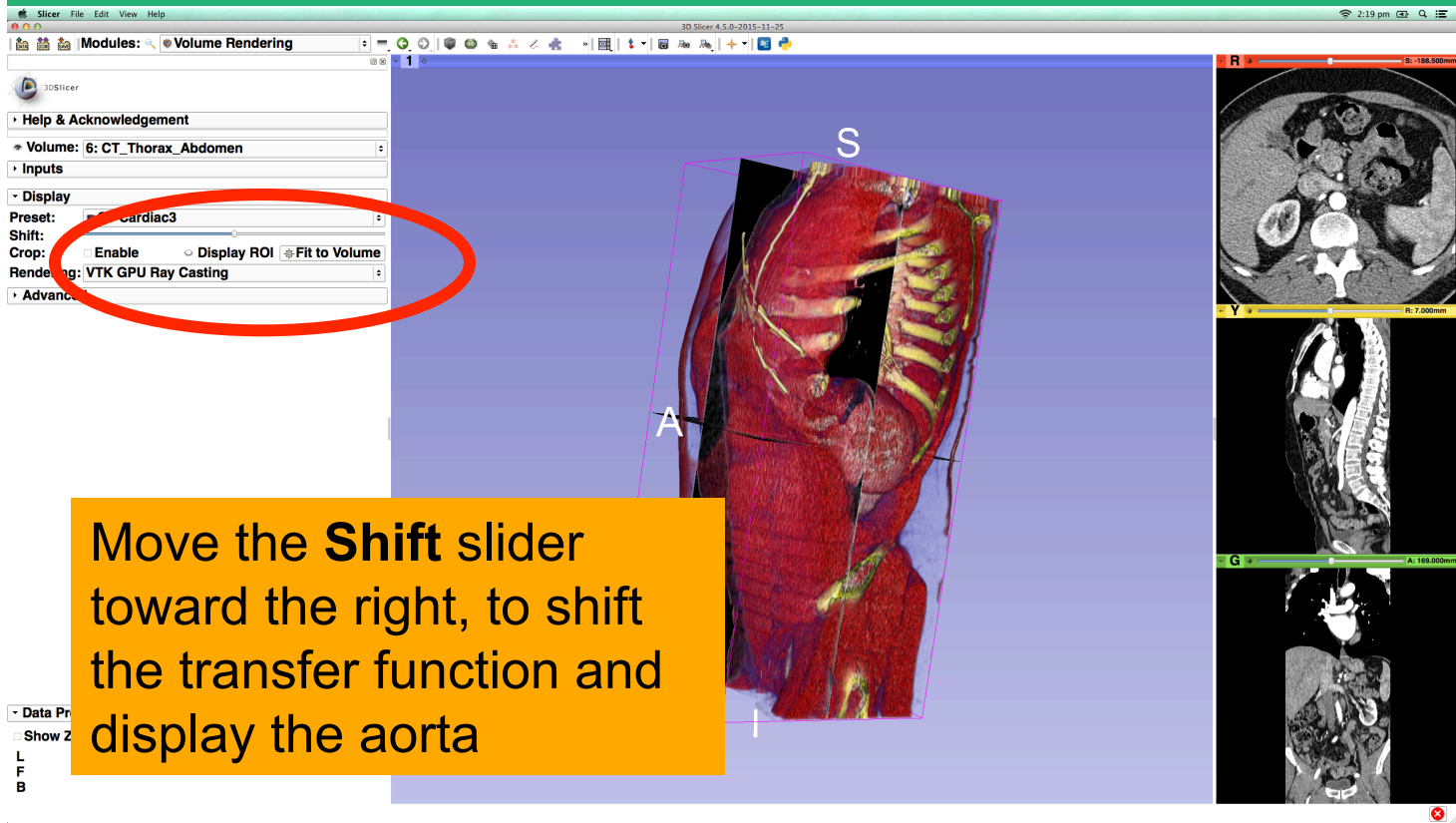

Move the **Shift** slider toward the right, to shift the transfer function and display the aorta



Volume Rendering

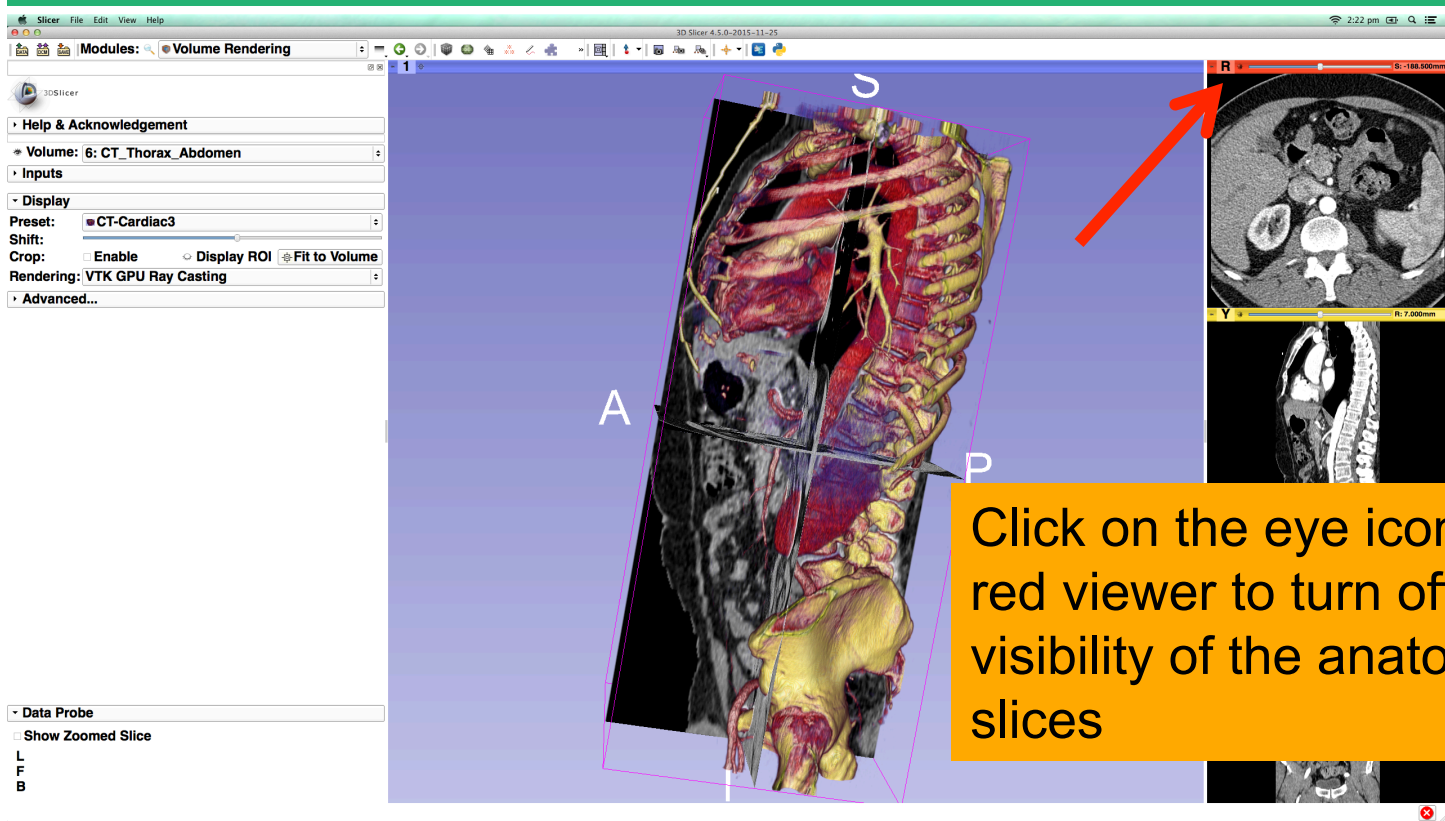

Click on the eye icon in the red viewer to turn off the visibility of the anatomical slices



Volume Rendering

Use the mouse in the 3D window to rotate the volume rendered image

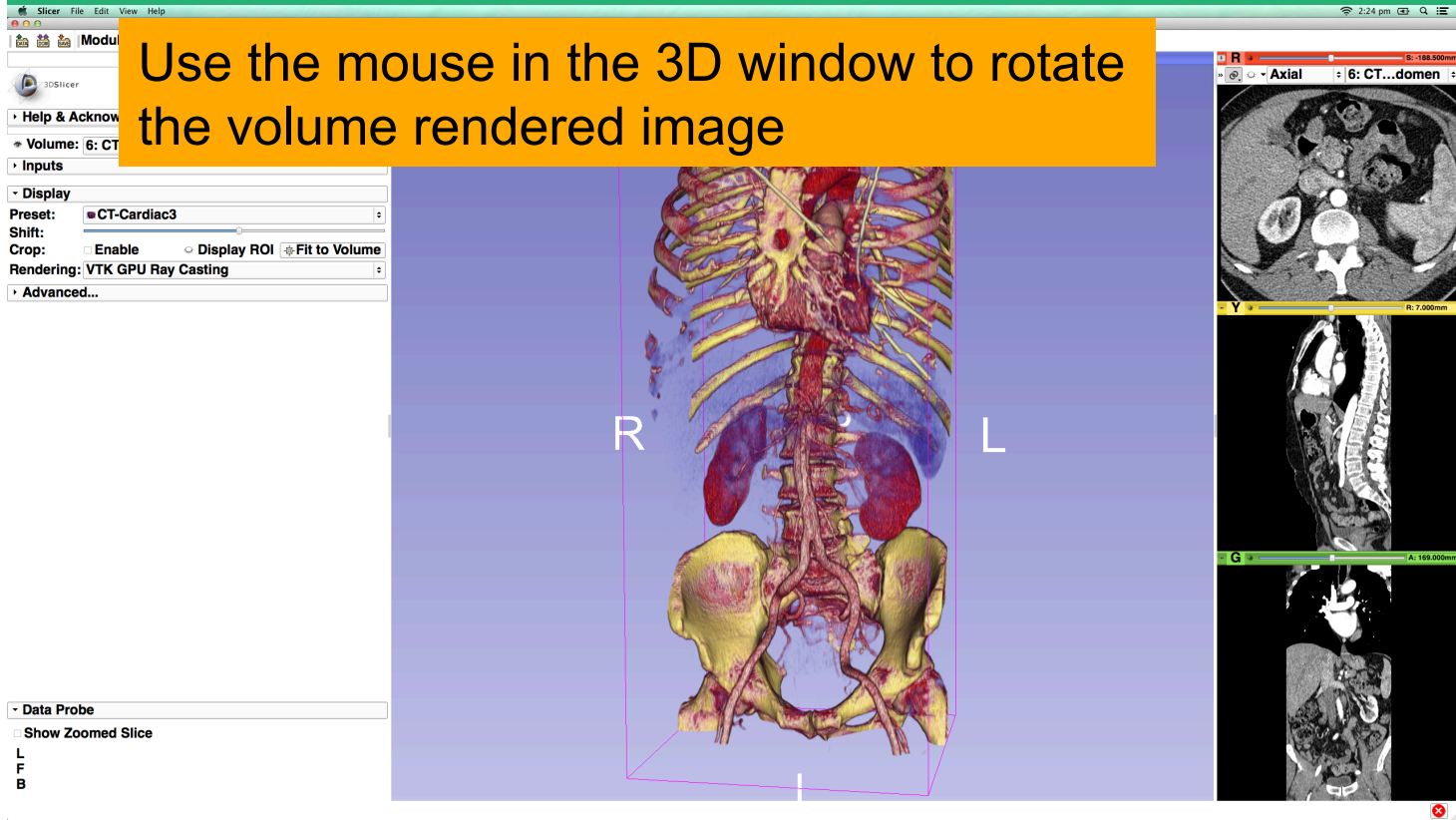



Volume Rendering



Click on the eye icon in the volume rendering panel to remove the volume rendered image from the 3D viewer



Volume Rendering

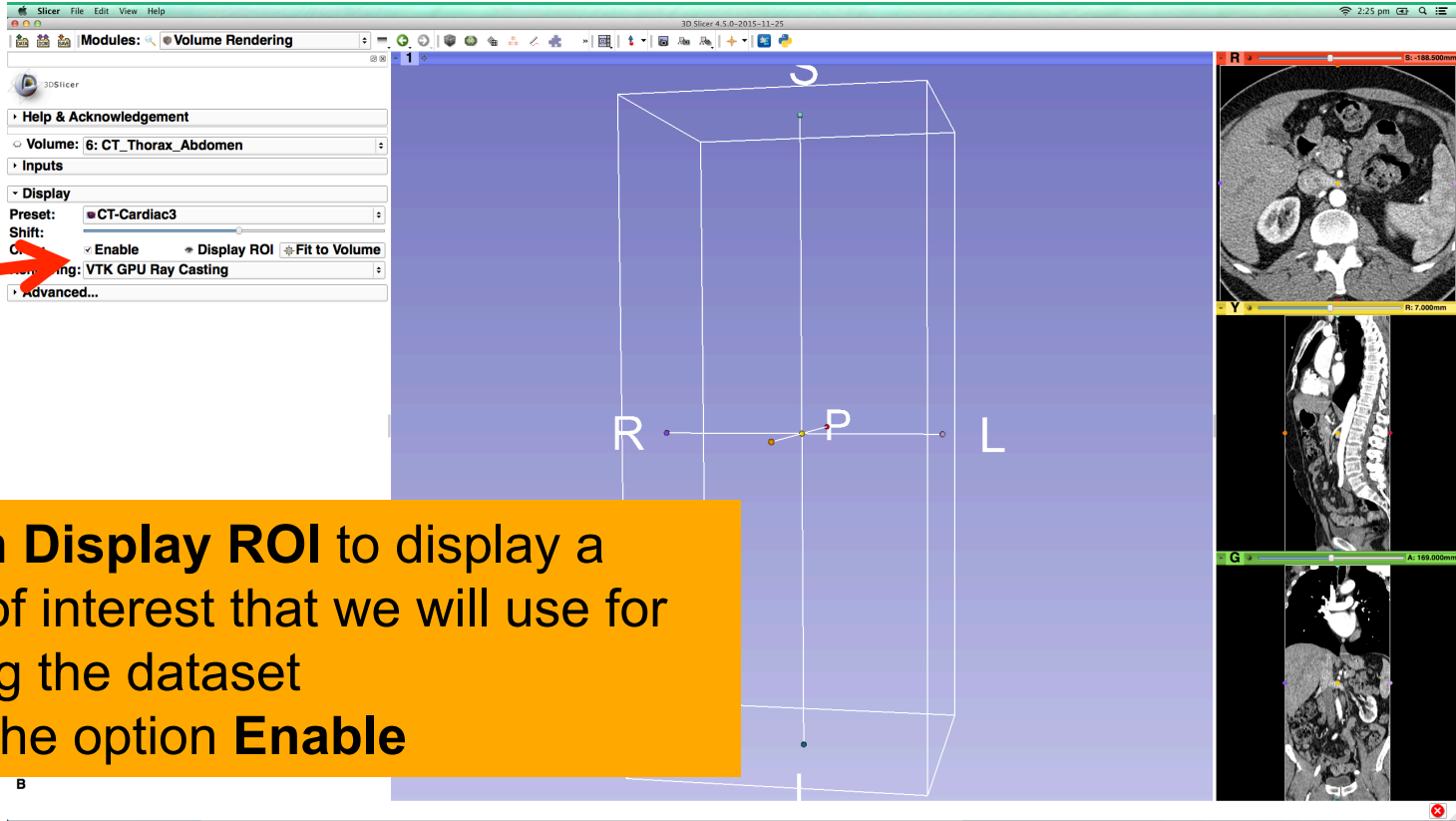

Click on **Display ROI** to display a region of interest that we will use for cropping the dataset
Check the option **Enable**



Volume Rendering

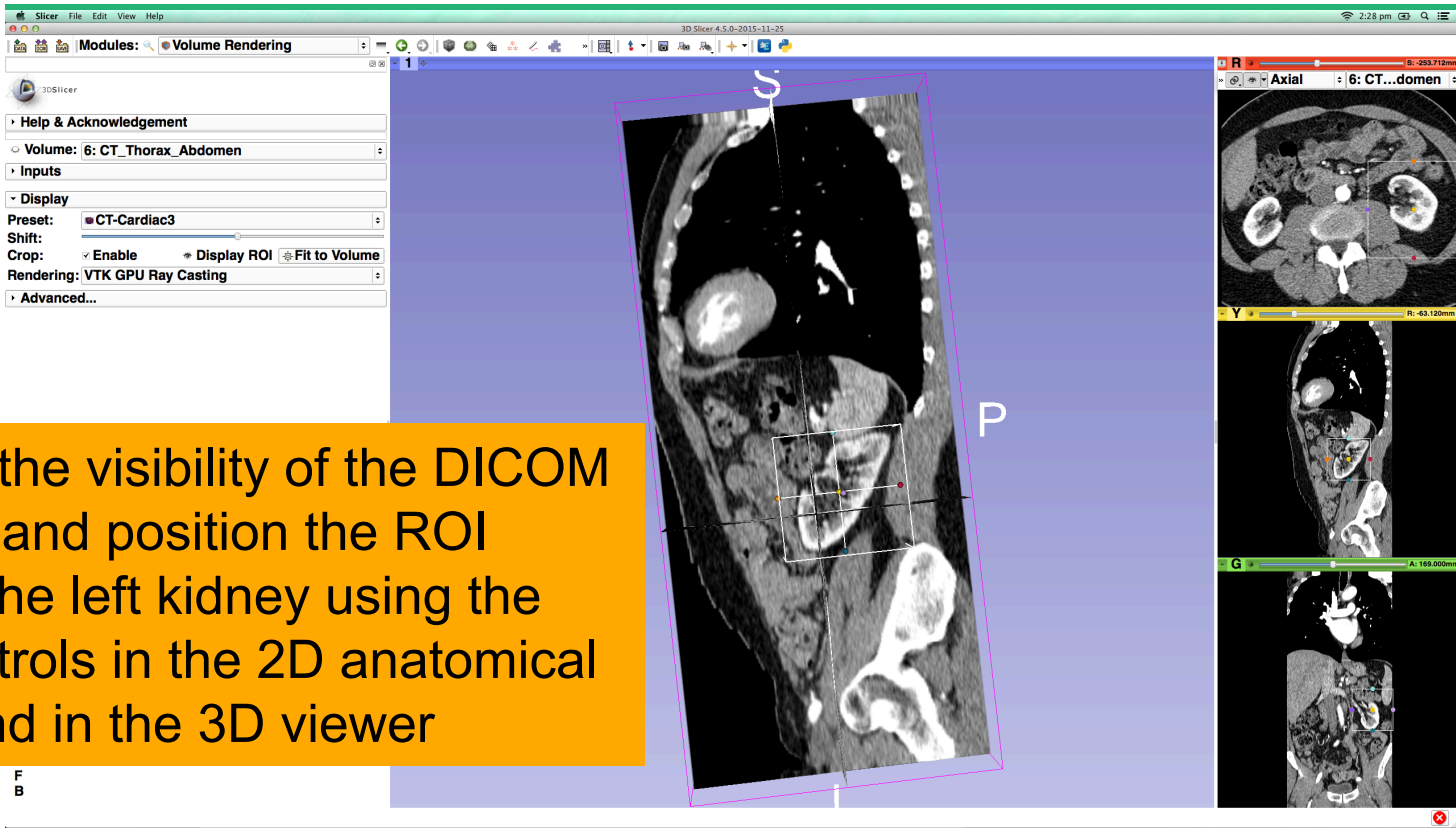

Turn on the visibility of the DICOM images, and position the ROI around the left kidney using the ROI controls in the 2D anatomical views and in the 3D viewer



Volume Rendering

A screenshot of the Slicer 4.5.0-2015-11-25 software interface. The 'Modules' panel on the left shows 'Volume Rendering' selected. The 'Display' panel shows 'Preset: CT-Cardiac3', 'Shift: [empty]', 'Crop: [checked] Enable [checked] Display ROI [checked] Fit to Volume', and 'Rendering: VTK GPU Ray Casting'. The main view shows a 3D volume rendering of a kidney in a sagittal plane, with 'A' and 'P' labels. A yellow callout box points to the eye icon in the 'Volume Rendering' module. A green callout box points to the kidney volume. The right side of the interface shows a multi-planar view with 'Axial' and '6: CT...domen' selected, showing a cross-section of the kidney.

Click on the eye icon to display the volume rendered image

Slicer displays the volume rendered image of the left kidney



Volume Rendering

Extend the ROI to the right kidney

Slicer displays the cropped volume rendered images showing the left and right kidney



Volume Rendering

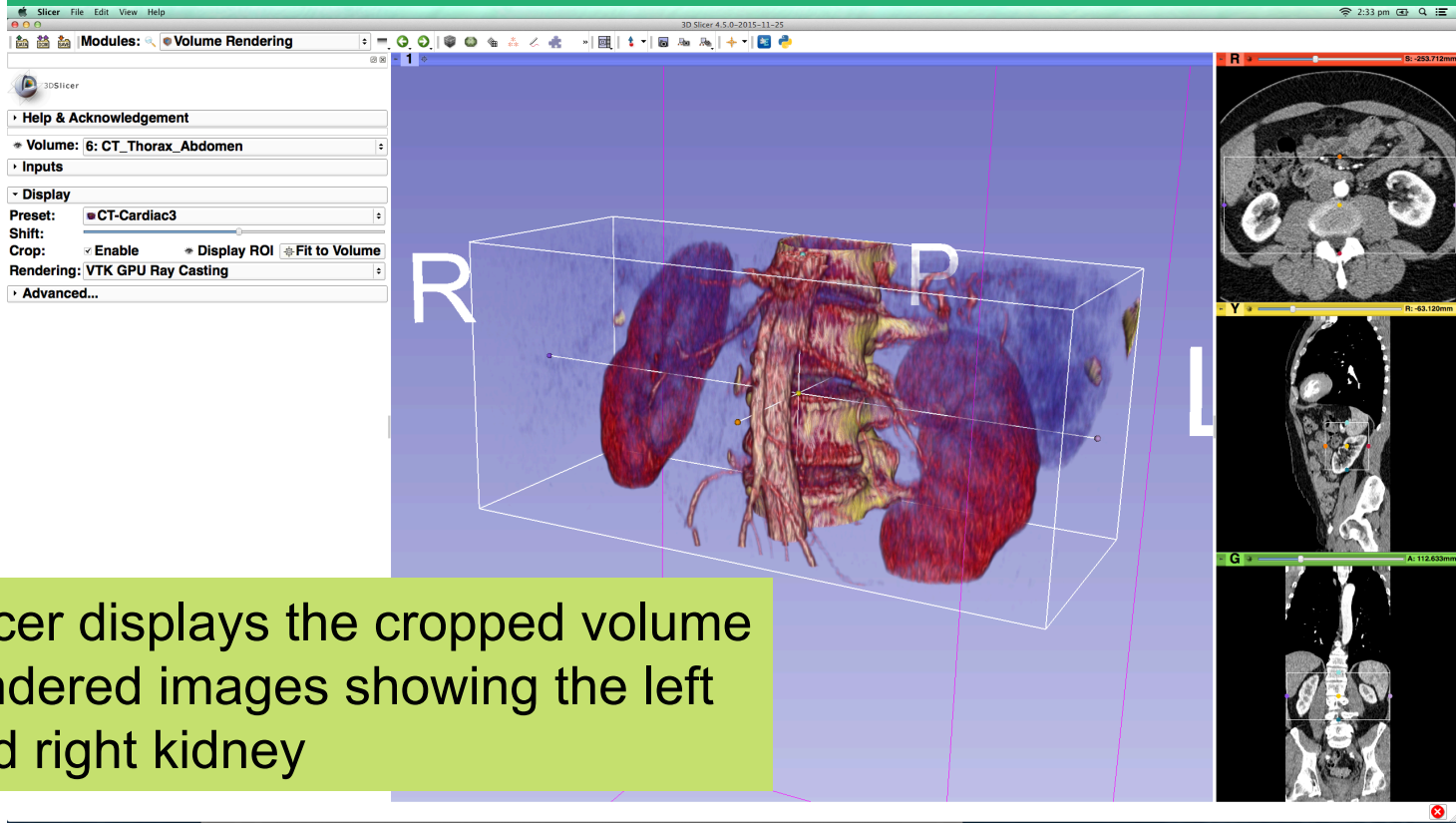

Slicer displays the cropped volume rendered images showing the left and right kidney



Volume Rendering

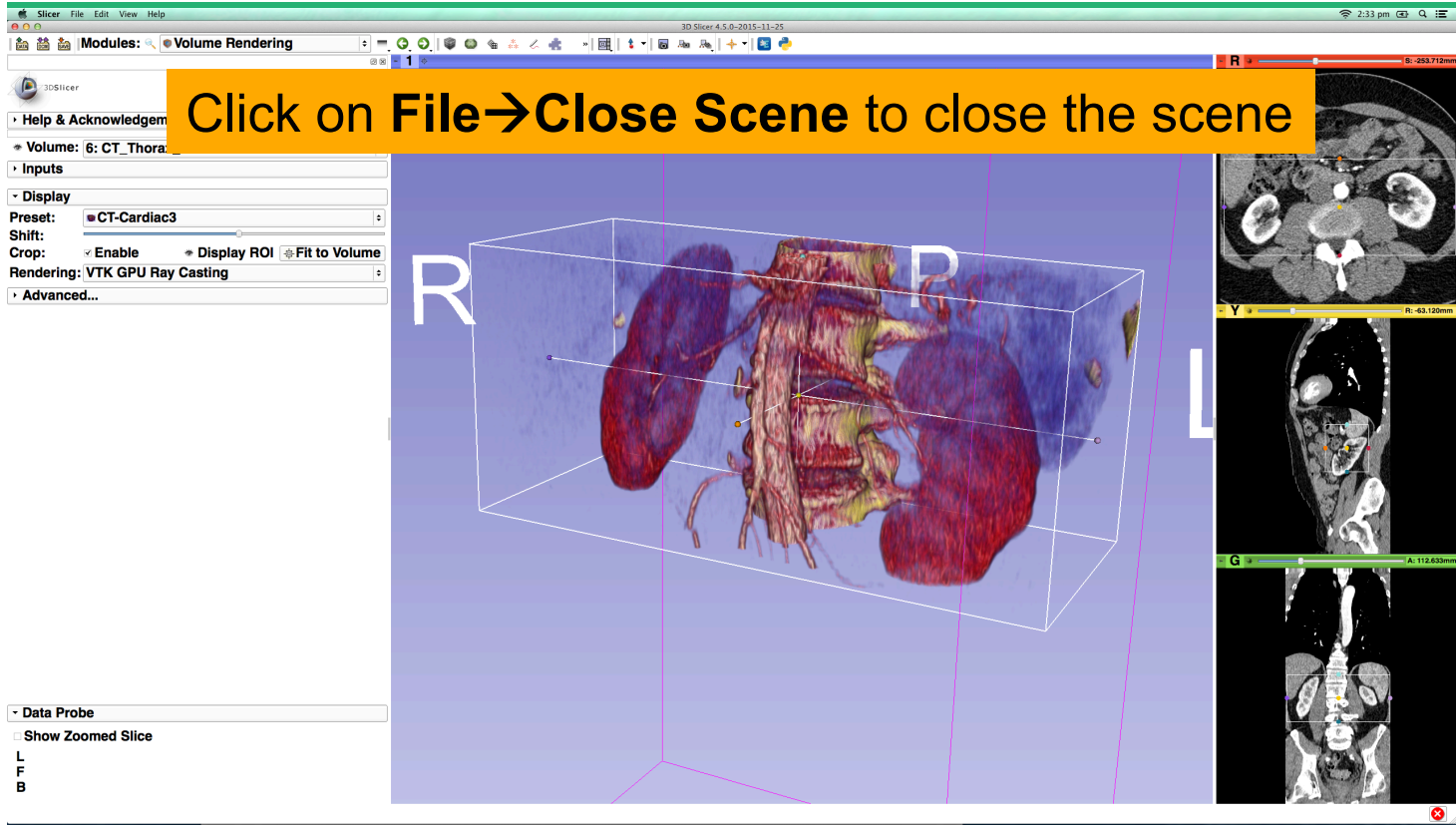



Volume Rendering



Click on Slicer → Quit to quit Slicer

Help & Acknowledgement

Help Acknowledgement



This work is supported by NA-MIC, NAC, BIRN, NCIGT, and the Slicer Community. See slicer.org for details. Some of the transfer functions were contributed by Kitware Inc. (VoIView)

Contributors: Julien Finet (Kitware), Alex Yarmarkovich (Isomics), Yanling Liu (SAIC-Frederick, NCI-Frederick), Andreas Freudling (SPL, BWH), Ron Kikinis (SPL and BWH)

Volume: Select a Volume

Inputs

Display

Preset: Select a Preset

Shift:

Crop: Enable Display ROI Fit to Volume

Rendering: VTK CPU Ray Casting

Advanced...

Data Probe

Show Zoomed Slice

L
F
B



Part IIb: 3D visualization of surface models of the brain



Loading the Head Scene

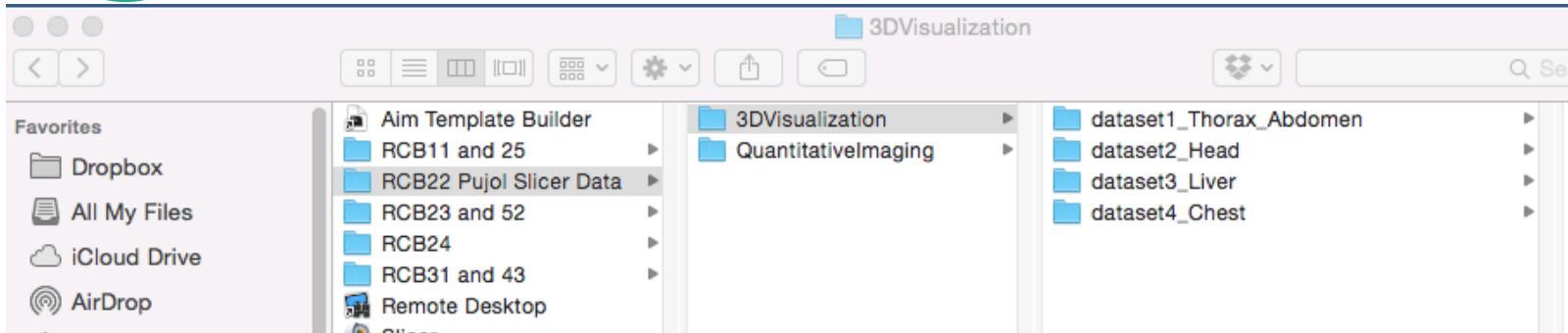

Browse to the directory **RCB22 Pujol Slicer Data**

Select the directory **3D Visualization**

Select the directory **dataset2_Head**



Loading the Head scene

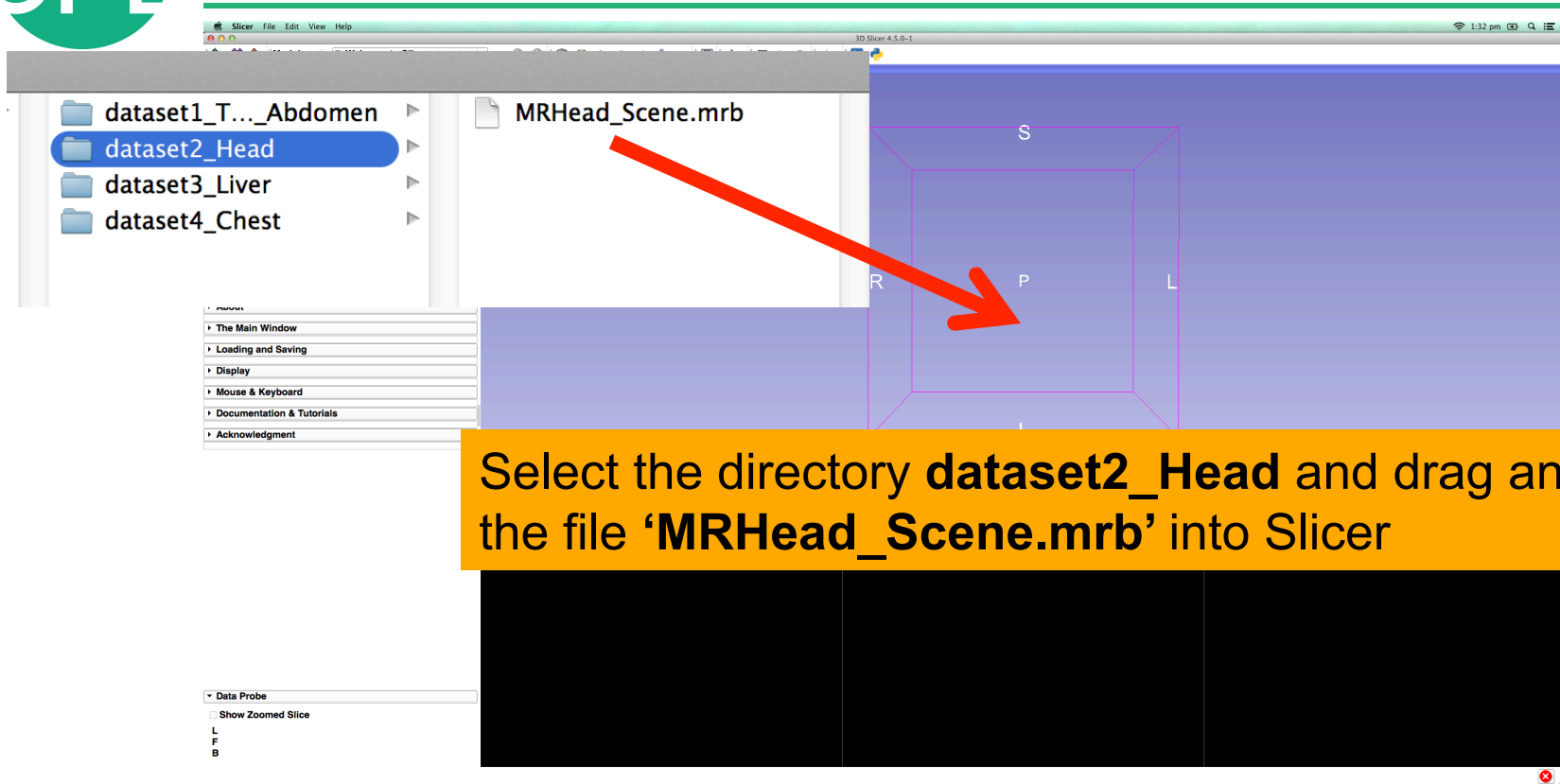

Select the directory **dataset2_Head** and drag and drop the file '**MRHead_Scene.mrb**' into Slicer



Tutorial Dataset

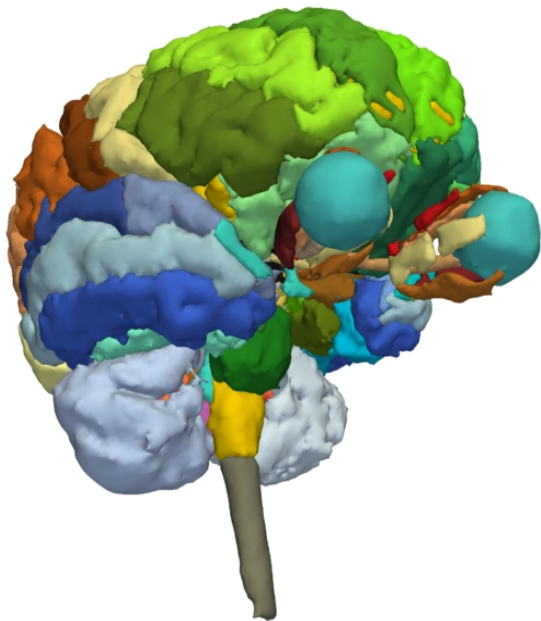

- The **MRHead_Scene.mrb** file is composed of an MR scan of the brain and 3D surface reconstructions of anatomical structures from the SPL-PNL Brain Atlas.
- The atlas by Talos, Jakab, Kikinis et al. is freely available at:

<http://www.spl.harvard.edu/publications/item/view/2037>



Loading the Head Scene

3D Slicer 4.5.0-2015-11-25

Welcome to Slicer

3DSlicer

Welcome

Load DICOM Data Load Data

Customize Slicer Download Sample Data

Feedback

Share your stories with us and let us know Slicer has enabled your research.

We are always interested in improving 3D Slicer. Your submission will be carefully read.

See more at <http://goo.gl/6Bvch>

About

The Main Window

Loading and Saving

Display

Mouse & Keyboard

Documentation & Tutorials

Acknowledgment

Show Zoomed Slice

L
F
B

Add data into the scene

Choose Directory to Add	Choose File(s) to Add	Show Options
	File	Description
<input checked="" type="checkbox"/>	...aset2_Head/MRHead_Scene.mrb	MRB Slicer Data Bundle

Reset OK Cancel

Click on **OK** to load the file **MRHead_Scene.mrb** into Slicer



Viewing the 3D Scene

Slicer displays the elements of the scene, which contains an MRI scan and a series of 3D surface models of the brain.

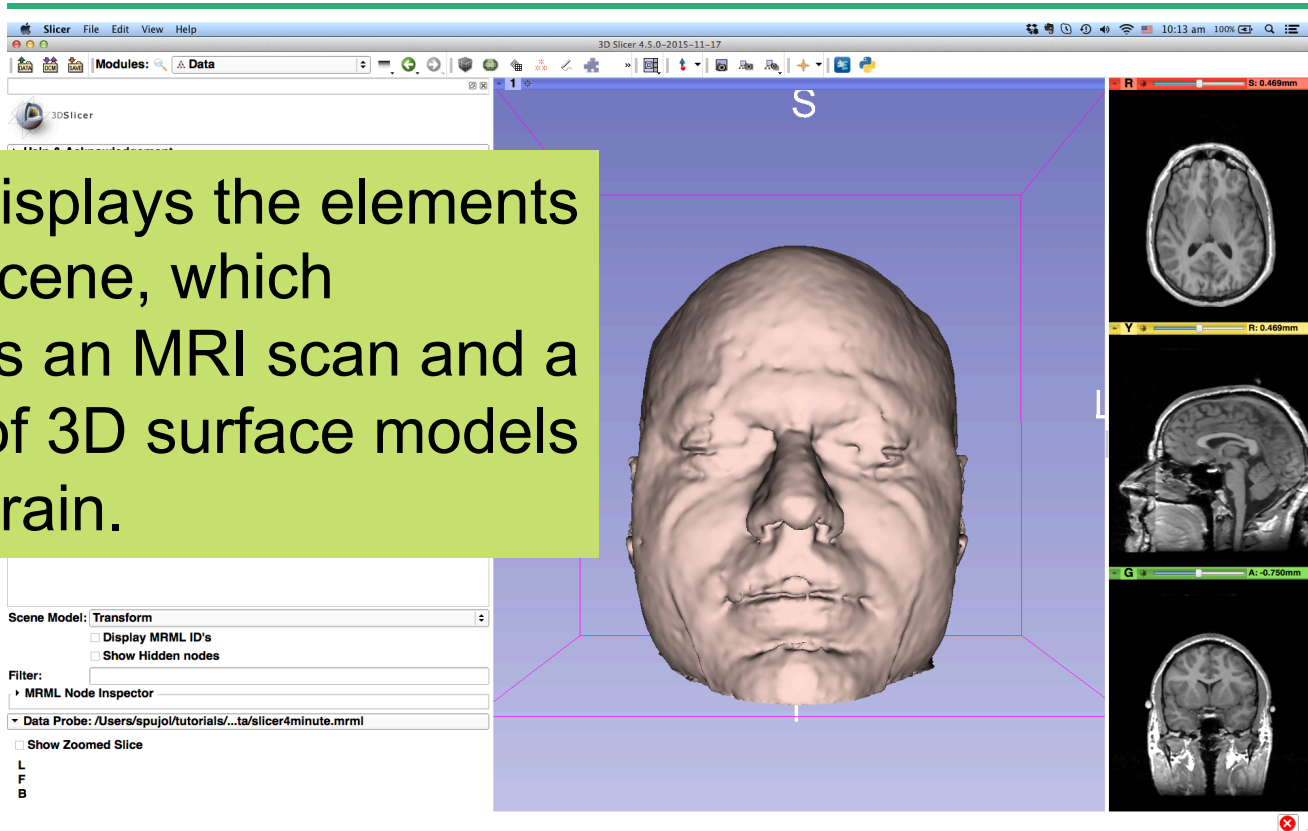



Viewing the 3D Scene

Select the module **Models** in the list of Slicer modules

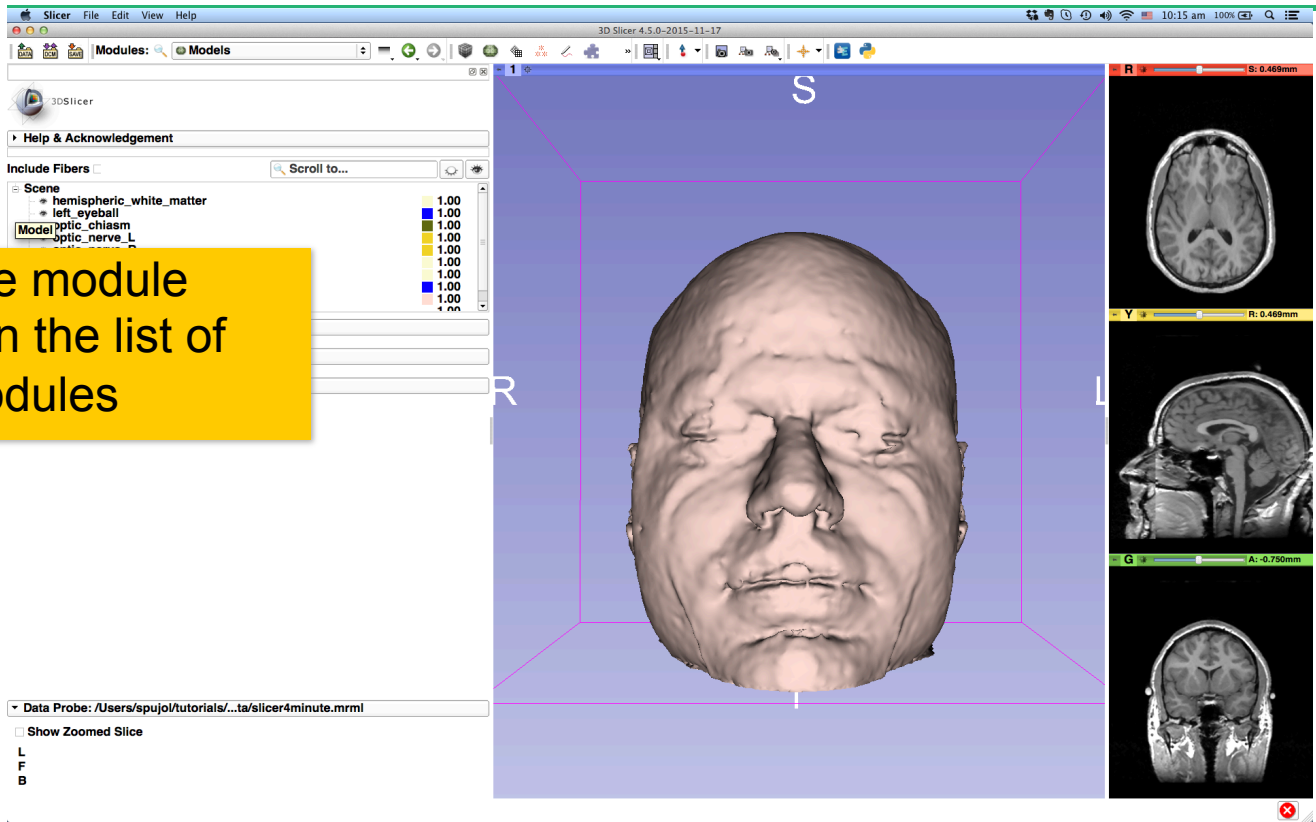



Basic 3D Interaction

Position the mouse in the 3D Viewer.

Hold down the **left mouse button** and **drag to rotate** the model.

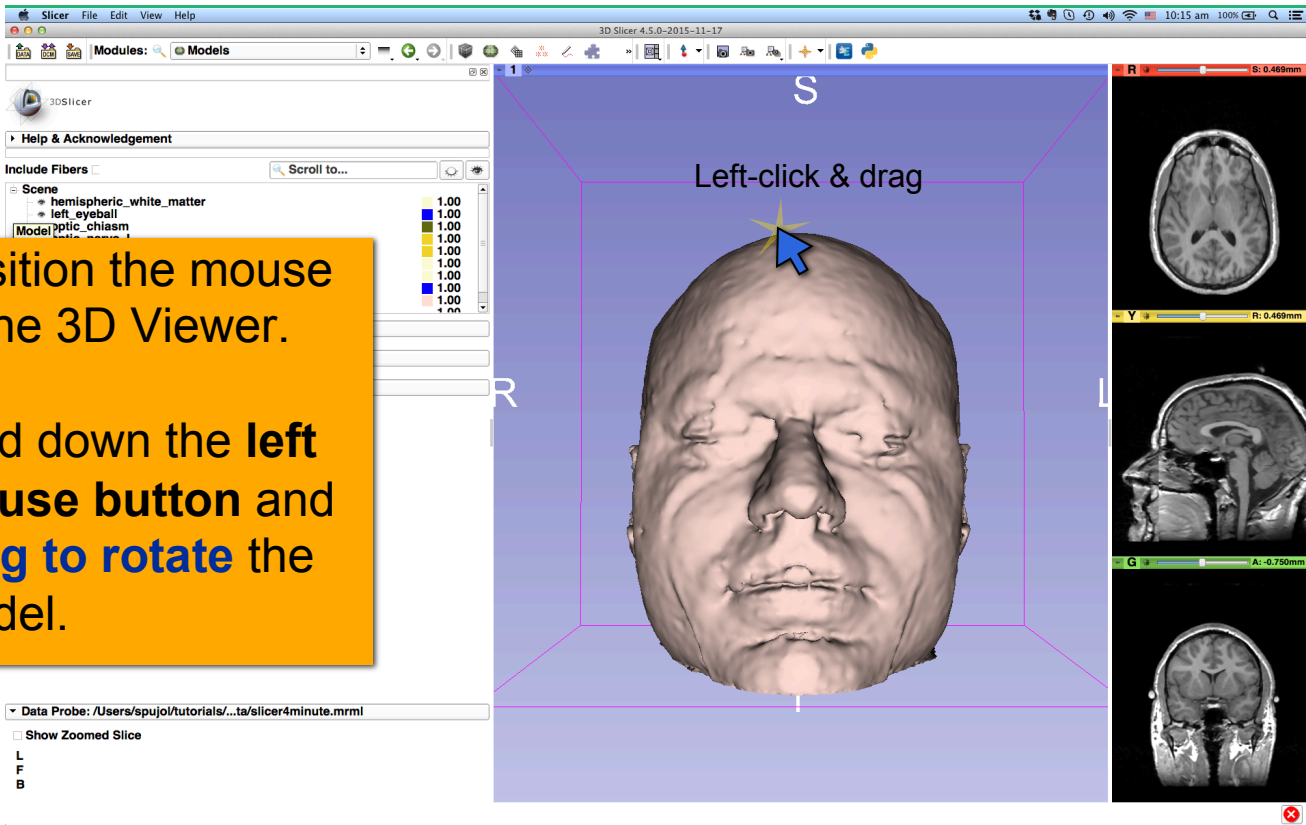



3D visualization of surface models of the brain

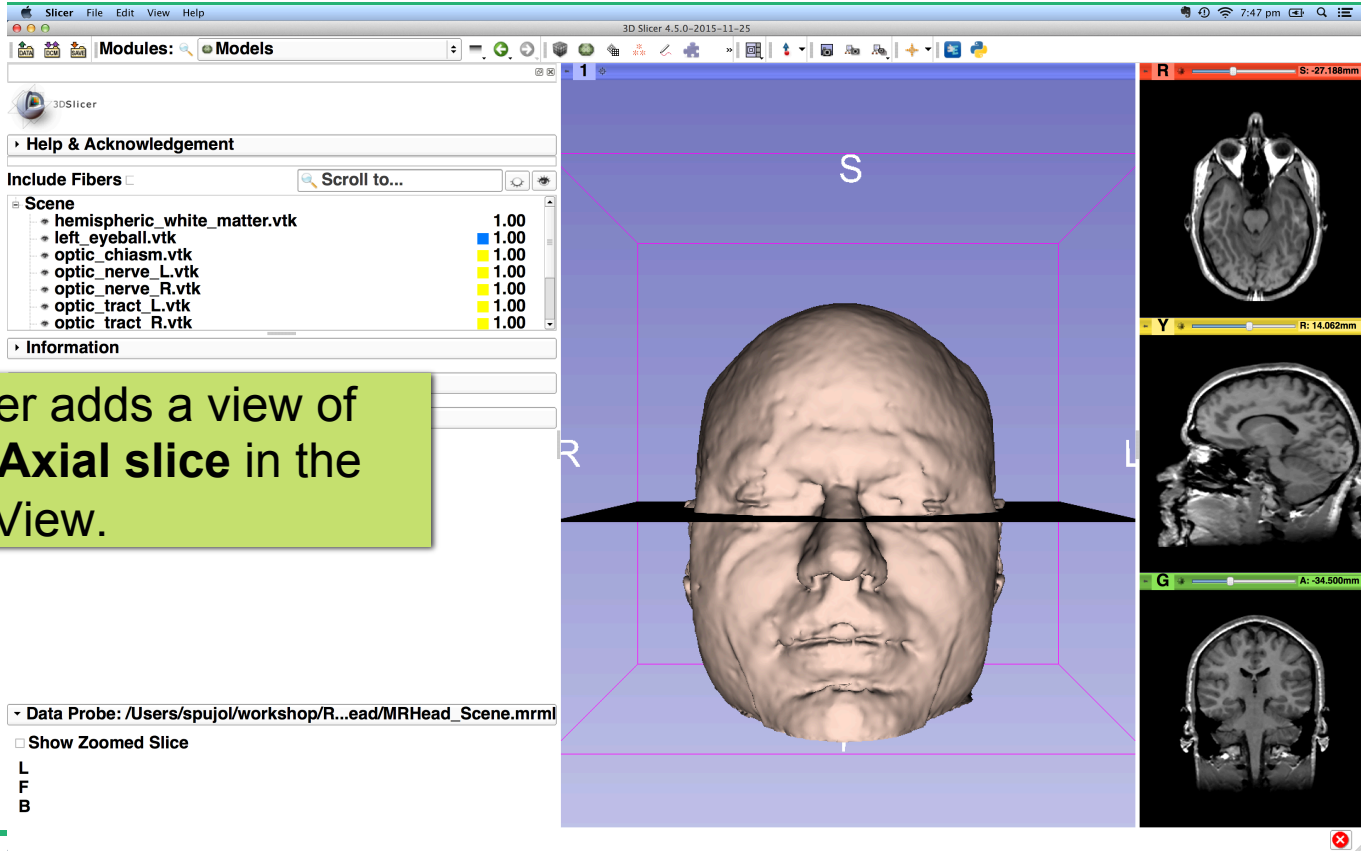

Slicer adds a view of the **Axial slice** in the 3D View.



3D visualization of surface models of the brain

The screenshot shows the 3D Slicer software interface. On the left, the 'Models' panel lists several files: optic_nerve_R.vtk, optic_tract_L.vtk, optic_tract_R.vtk, right_eyeball.vtk, Skin.vtk, and skull_bone.vtk. The 'Skin.vtk' model is highlighted with a blue selection bar and an orange rectangular box. Below this, the 'Display' tab is expanded, showing settings for 'Visibility' (Visible: checked, View: All), 'Representation' (Color: #ffddce, Opacity: 1.00), and 'Lighting'. A red arrow points from the left towards the 'Opacity' slider. The main 3D view shows a semi-transparent 3D model of a human head. To the right, there are three axial MRI slices. A yellow text box is overlaid on the 3D view, containing the following instructions:

Select the model **Skin.vtk**

Expand the **Display** tab and change the opacity of the model from **1.0** to **0.0**.



3D visualization of surface models of the brain

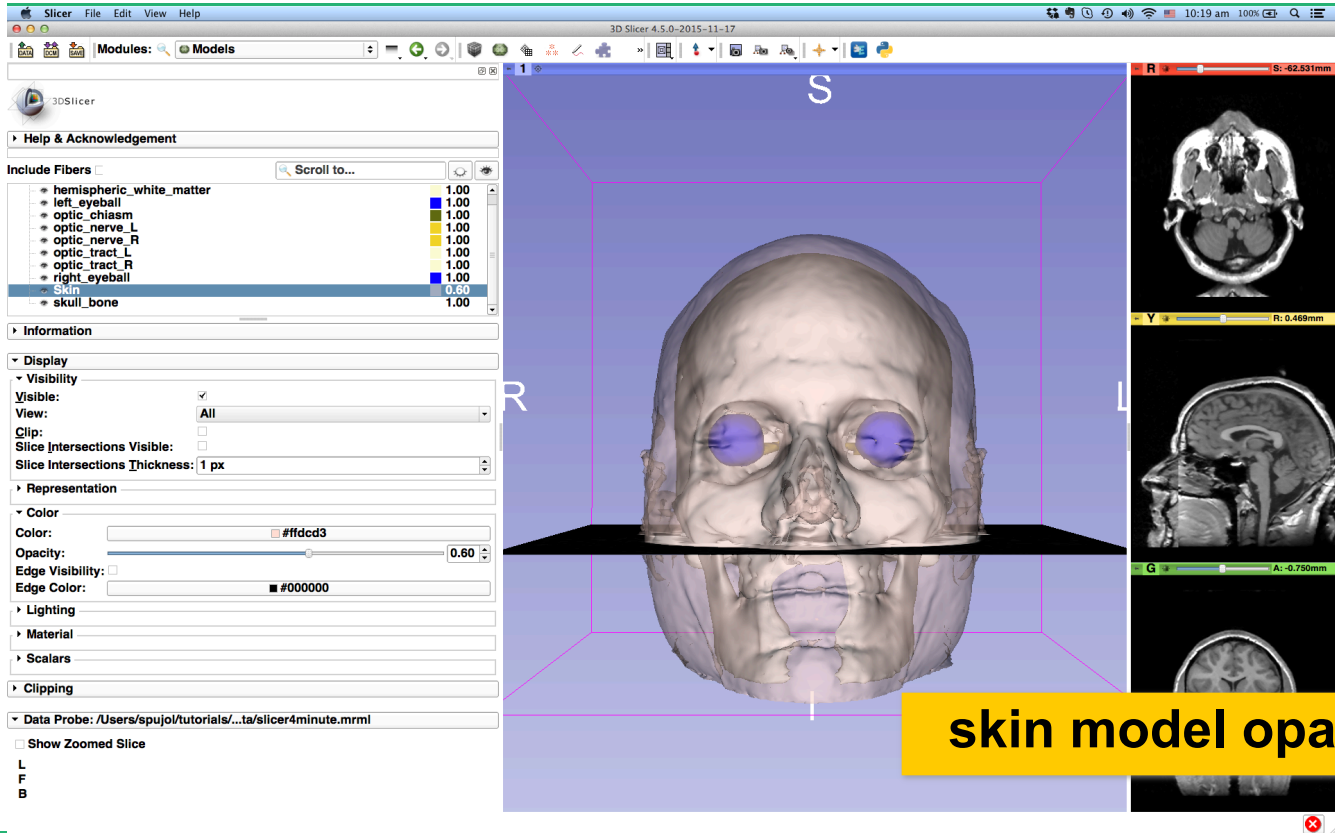



3D visualization of surface models of the brain

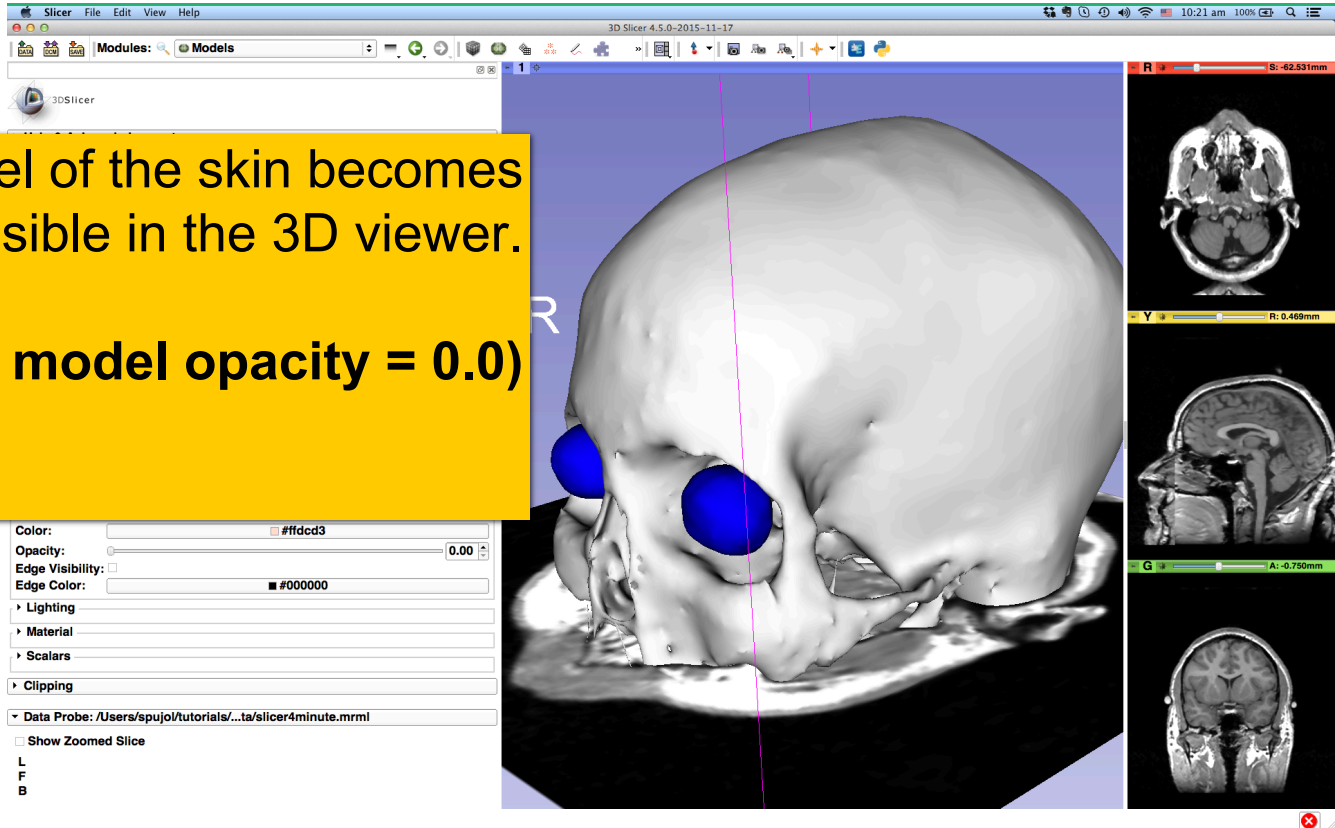

The model of the skin becomes invisible in the 3D viewer.
(skin model opacity = 0.0)



3D visualization of surface models of the brain

Click on the **Slice Visibility** icon in the **Green Slice Viewer** to display the Coronal Slice in the 3D Viewer.

The screenshot shows the Slicer 4.5.0-2015-11-25 interface. On the left, the '3D Slicer' sidebar shows a tree view with 'opti...', 'right', 'Skul', and 'skul'. Below it, the 'Display' panel is expanded to 'Visibility', showing 'Visible: All', 'Clip: []', 'Slice Intersections Visible: []', and 'Slice Intersections Thickness: 1 px'. The 'Representation' panel shows 'Color: #ffddce', 'Opacity: 0.00', 'Edge Visibility: []', and 'Edge Color: #000000'. The 'Data Probe' is set to '/Users/spujol/workshop/R...ead/MRHead_Scene.mrml'. At the bottom left, 'Show Zoomed Slice' is unchecked, and 'L', 'F', and 'B' are listed. The main 3D view shows a skull model with a horizontal slice plane. On the right, the 'Green Slice Viewer' is active, displaying a coronal MRI slice. A red arrow points from the skull model to the 'Coronal' slice viewer.



3D visualization of surface models of the brain



Select the 3D model **skull_bone.vtk** in the Model Hierarchy

Turn on the **Clip** option in the **Display** tab

3D Slicer

- right_eye0011.vtk 1.00
- Skin.vtk 0.00
- skull_bone.vtk 1.00**

Information

Display

Visibility

Visible:

View: All

Clip:

Slice Intersections Visible:

Slice Intersections Thickness: 1 px

Representation

Color

Color: #ffffff

Opacity: 1.00

Edge Visibility:

Edge Color: #000000

Lighting

Material

Scalars

Data Probe: /Users/spujol/workshop/R...ead/MRHead_Scene.mrml

Show Zoomed Slice

L
F
B



3D visualization of surface models of the brain

Browse through the **coronal slices** to expose the 3D model of the **white matter**, and the left and right **optic nerves**

3D Slicer 4.5.0-2015-11-25

1.00
0.00
1.00

1

R

L

S

I

Color: #ffffff

Opacity: 1.00

Edge Visibility:

Edge Color: #000000

Representation

Color

Opacity

Edge Visibility

Edge Color

Lighting

Material

Scalars

Data Probe: /Users/spujol/workshop/R...ead/MRHead_Scene.mrml

Show Zoomed Slice

L

F

B

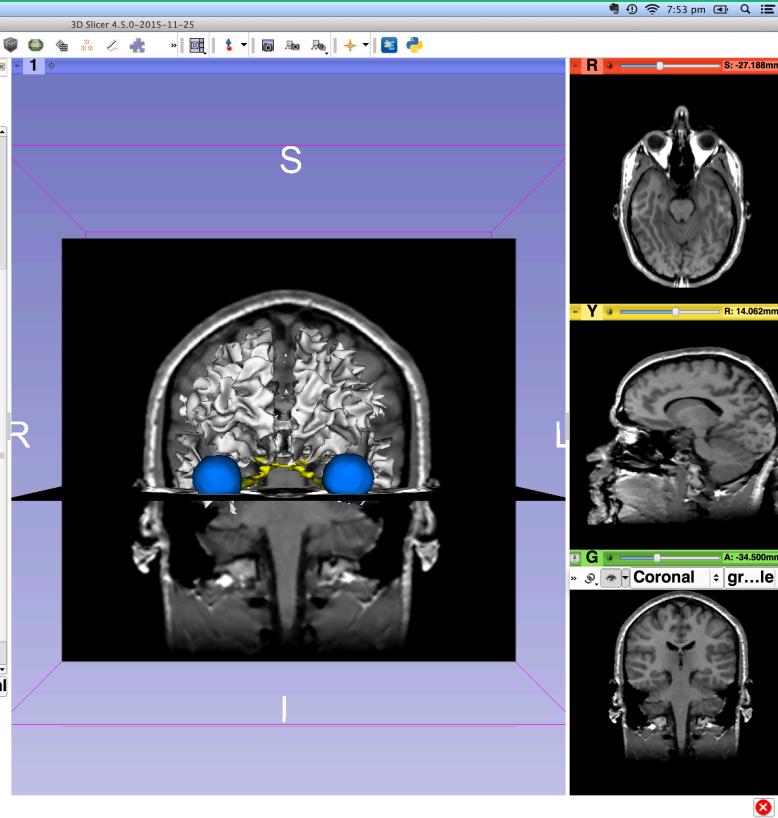



3D visualization of surface models of the brain

Select the **hemispheric_white_matter** model and turn off its visibility.

The screenshot shows the 3D Slicer interface. The Hierarchy panel on the left lists the following models and their visibility status:

Model Name	Visibility
hemispheric_white_matter.vtk	1.00
left_eyeball.vtk	1.00
optic_chiasm.vtk	1.00
optic_nerve_L.vtk	1.00
optic_nerve_R.vtk	1.00
optic_tract_L.vtk	1.00
optic_tract_R.vtk	1.00
right_eyeball.vtk	1.00
Skin.vtk	0.00
skull_bone.vtk	1.00

The main 3D view shows a brain model with two blue spheres representing the eyeballs. The Hierarchy panel is expanded to show the 'Display' section, where the 'Visibility' checkbox is checked and the 'View' is set to 'All'. The 'Representation' section is also visible.



3D visualization of surface models of the brain

Slicer displays the **optic nerves**, **optic chiasm** and **optic tracts** overlaid on the **MR images** of the brain.

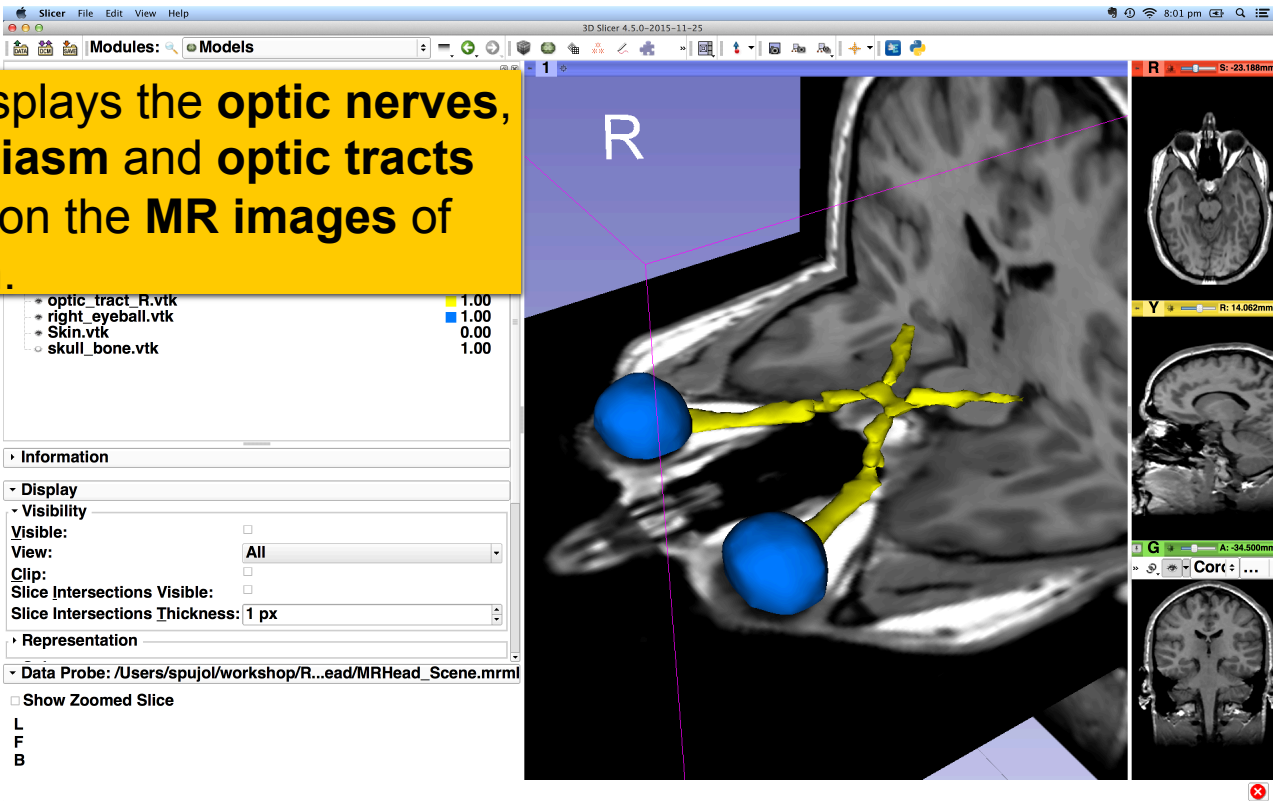



Close the existing scene and all its data

Select **File** → **Close Scene**

Select **Slicer** → **Quit** to exit the software





Course Overview

Part I: Introduction to the 3D Slicer software

Part II: 3D Data Loading and visualization of DICOM images

Volume Rendering of thoraco-abdominal CT data

Surface Rendering of MR head data

Part III: 3D interactive exploration of the anatomy

Interactive Exploration of the Segments of the liver

Interactive Exploration of the Segments of the lung

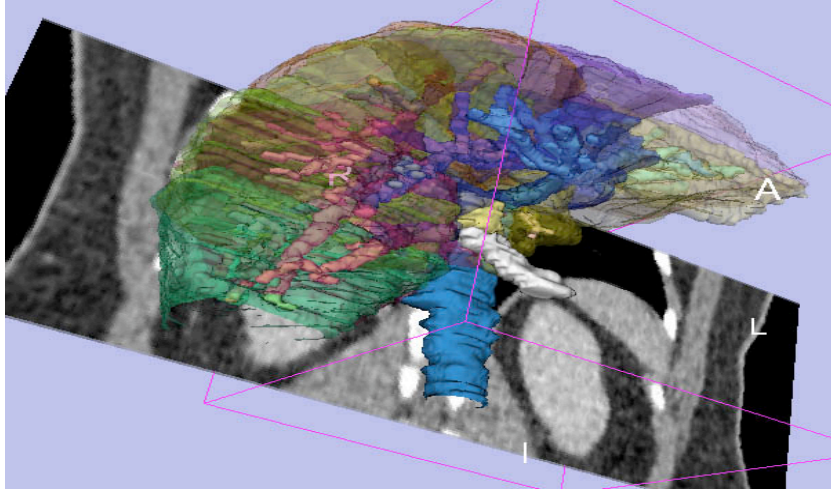

Part III-a:

Interactive 3D Visualization
of the segments of the liver

Anatomy of the liver

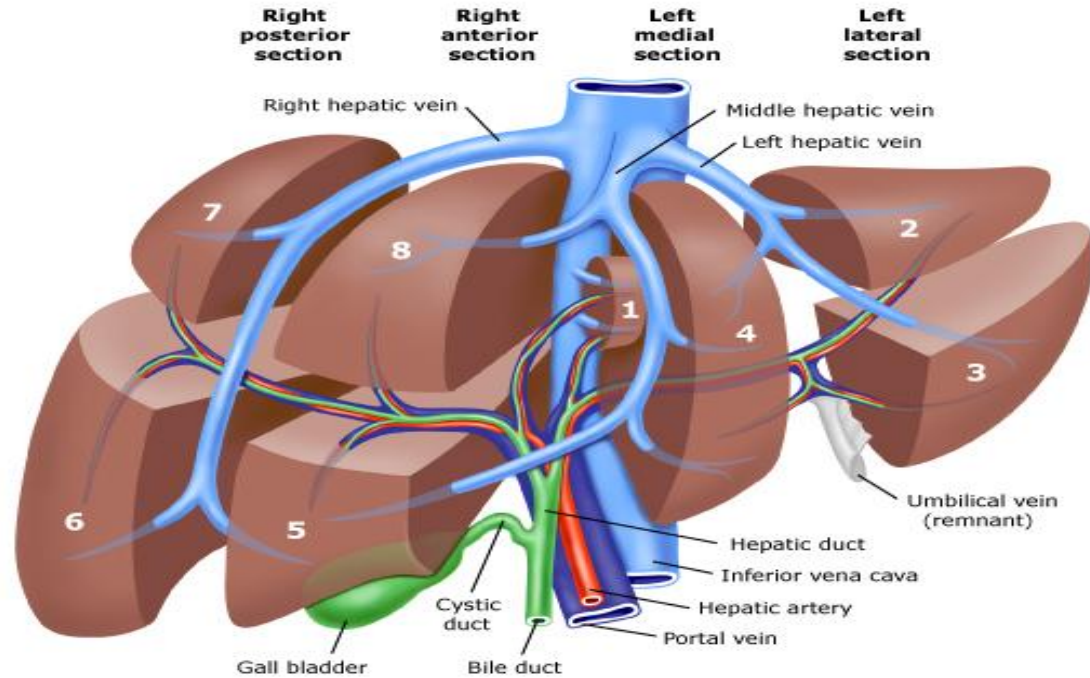



Liver dataset

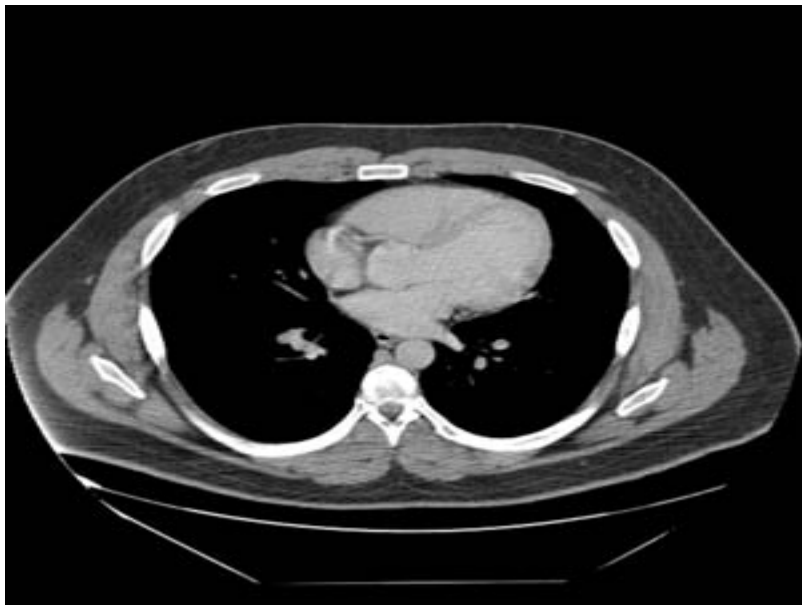

The liver dataset is a contrast-enhanced CT abdominal scan of a healthy 36 year-old male.



3D segments of the liver

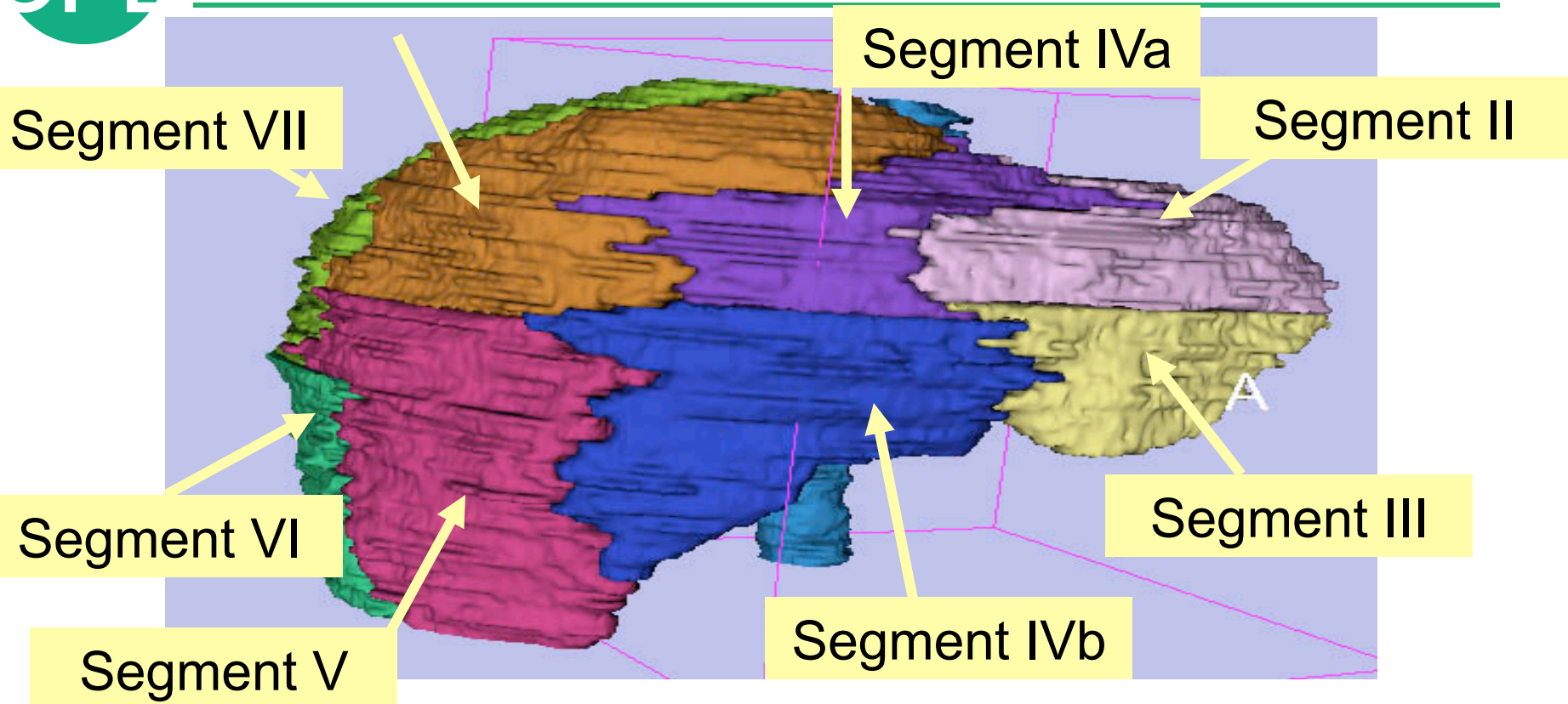



3D segments of the liver

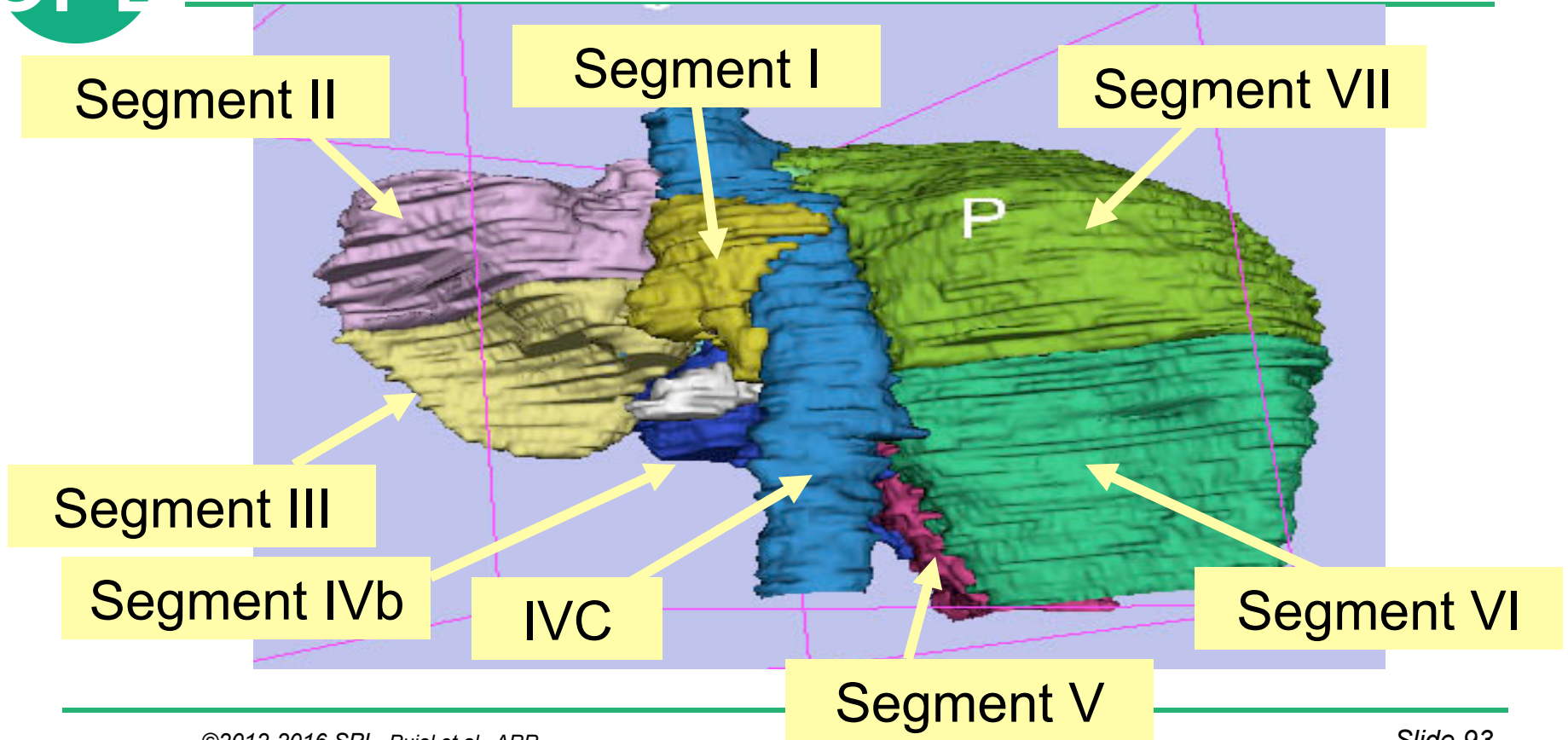



Liver vasculature

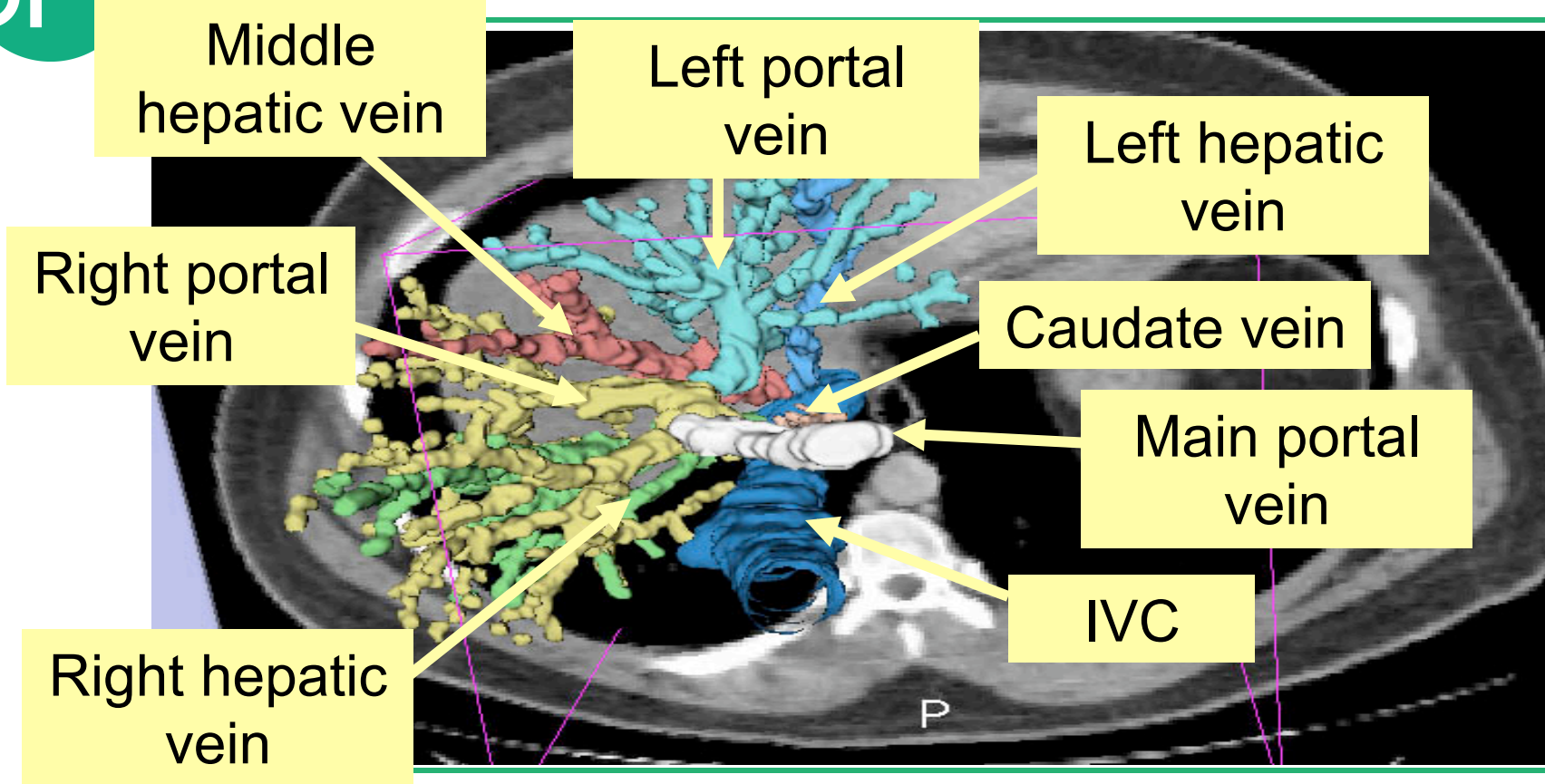



Loading the Liver Scene

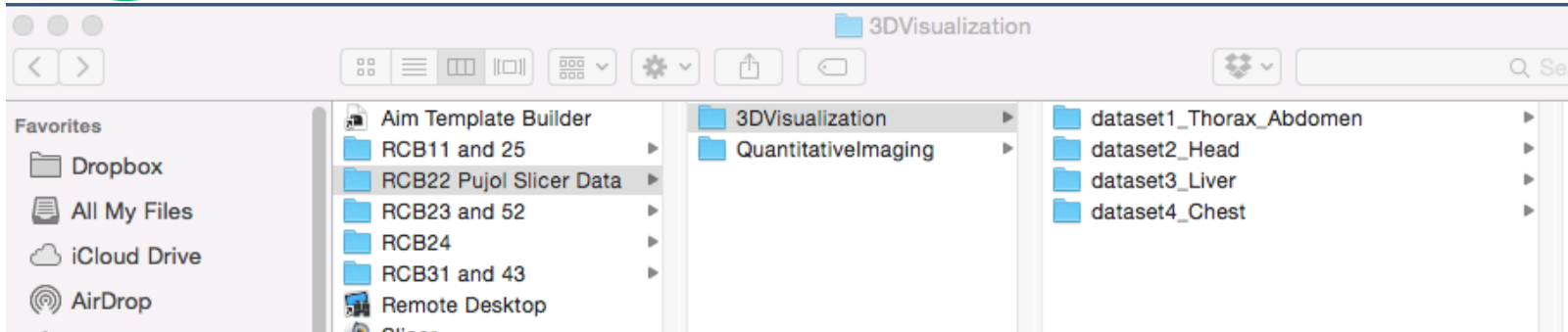

Browse to the directory **RCB22 Pujol Slicer Data**

Select the directory **3D Visualization**

Select the directory **dataset3_Liver**



Loading the Liver scene

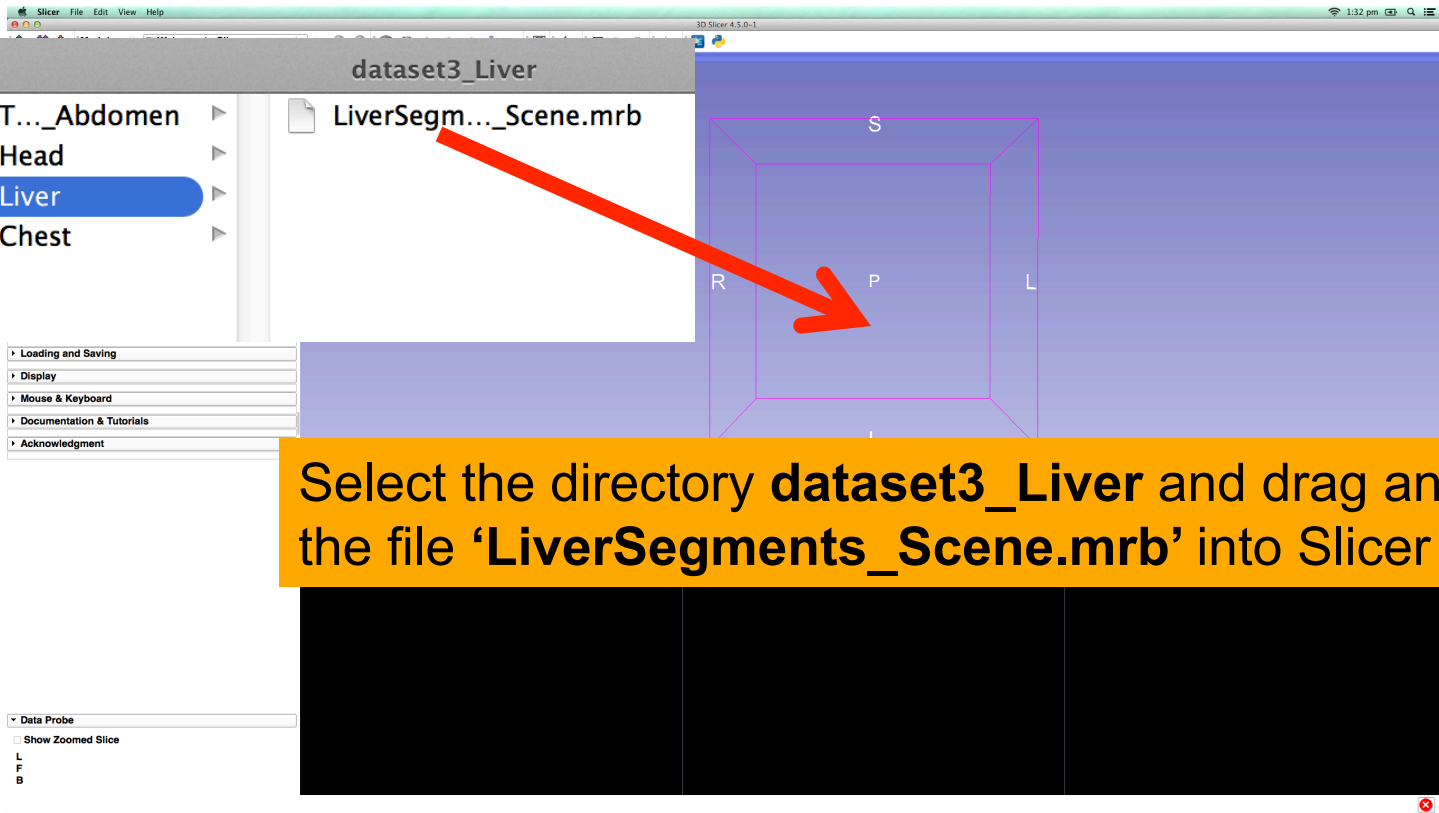

Select the directory **dataset3_Liver** and drag and drop the file '**LiverSegments_Scene.mrb**' into Slicer



Loading the Liver Scene

The screenshot shows the 3D Slicer interface. On the left, there is a 'Welcome' dialog with buttons for 'Load DICOM Data', 'Load Data', 'Customize Slicer', and 'Download Sample Data'. Below this is a 'Feedback' section with a message and a list of links. A file selection dialog is open in the center, titled 'Add data into the scene'. It has two tabs: 'Choose Directory to Add' and 'Choose File(s) to Add'. The 'Choose File(s) to Add' tab is active, showing a table with the following content:

File	Description
...DVisualization_RSNA2015/dataset3_Liver/LiverSegments_Scene.mrb	MRB Slicer Data Bundle

At the bottom of the dialog are 'Reset', 'OK', and 'Cancel' buttons. A yellow banner at the bottom of the screenshot contains the text: 'Click on OK to load the scene into Slicer'.



Liver Segments Scene

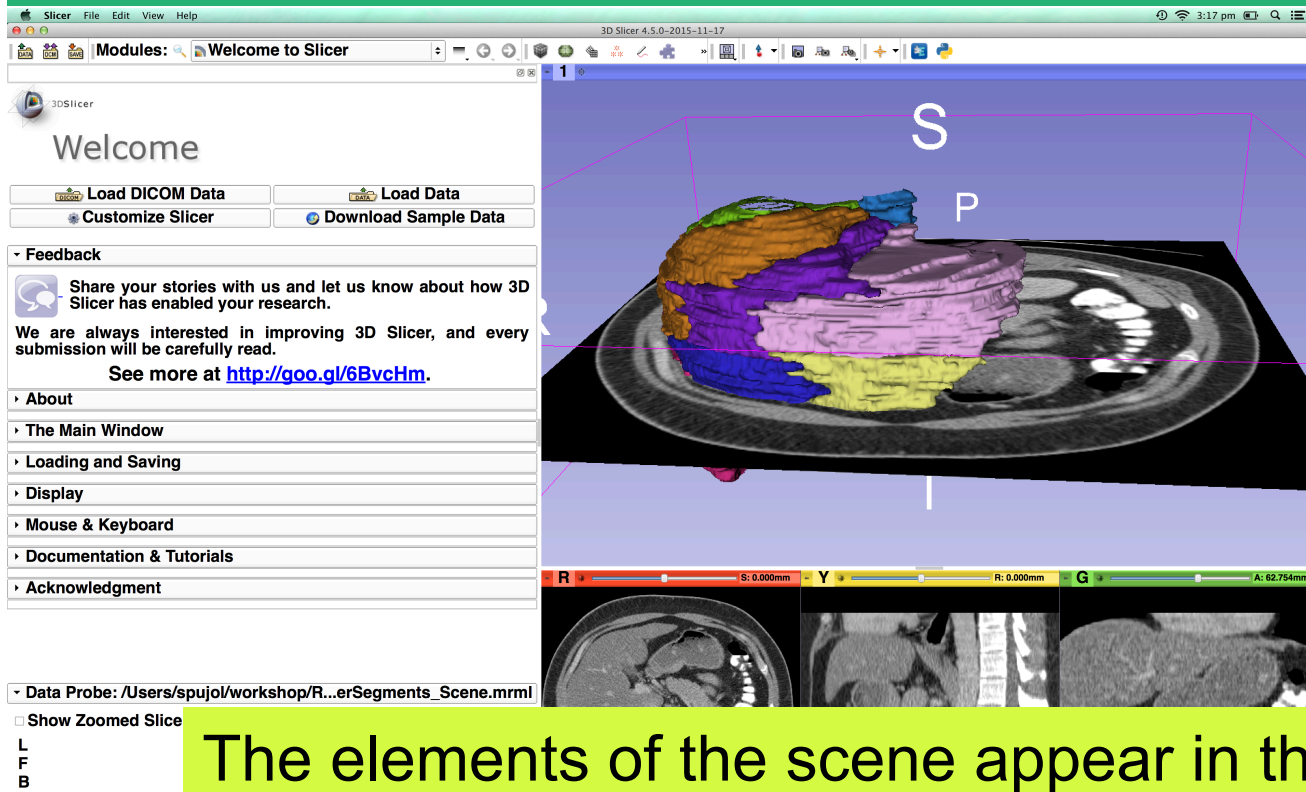

The elements of the scene appear in the Viewer



3D models of the liver

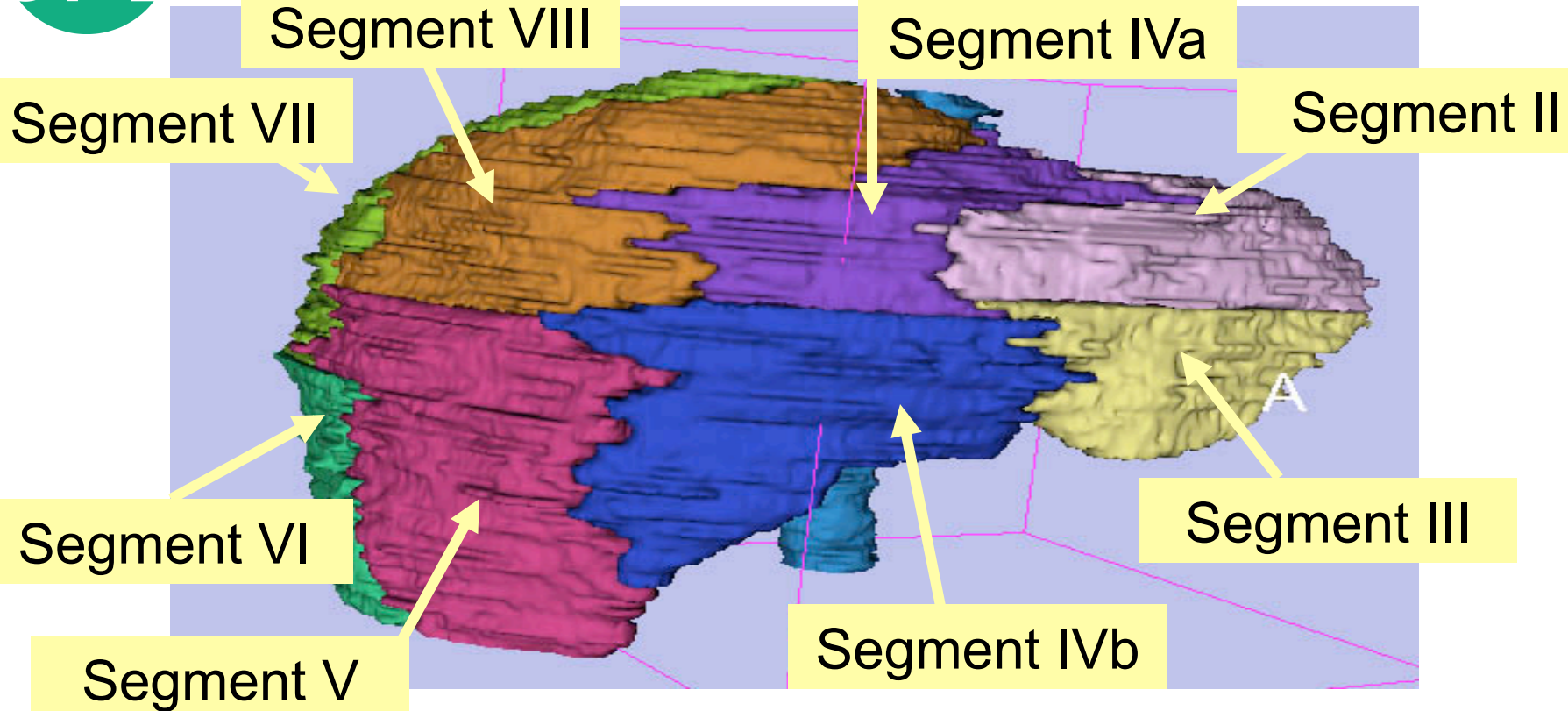



3D models of the liver

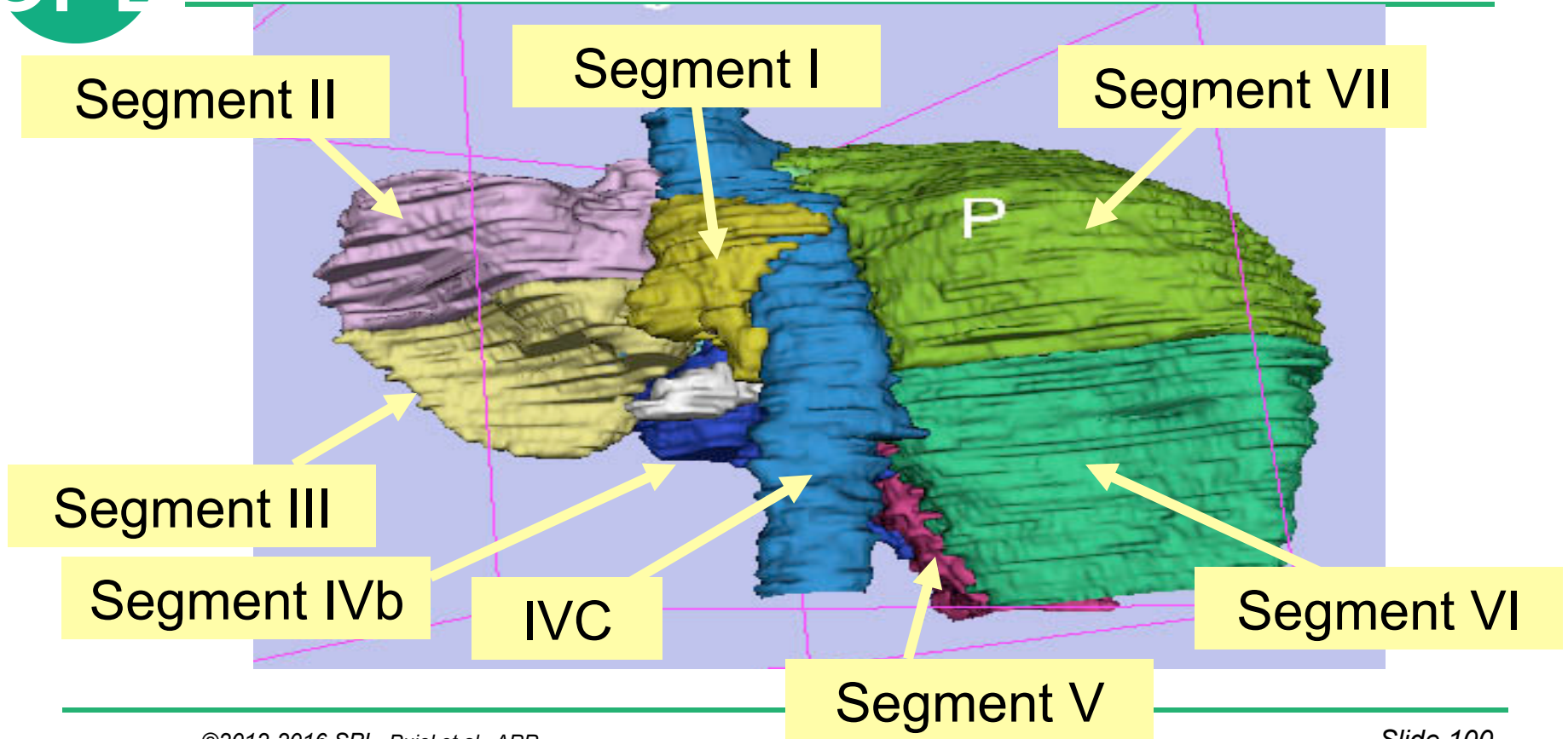



3D models of the liver

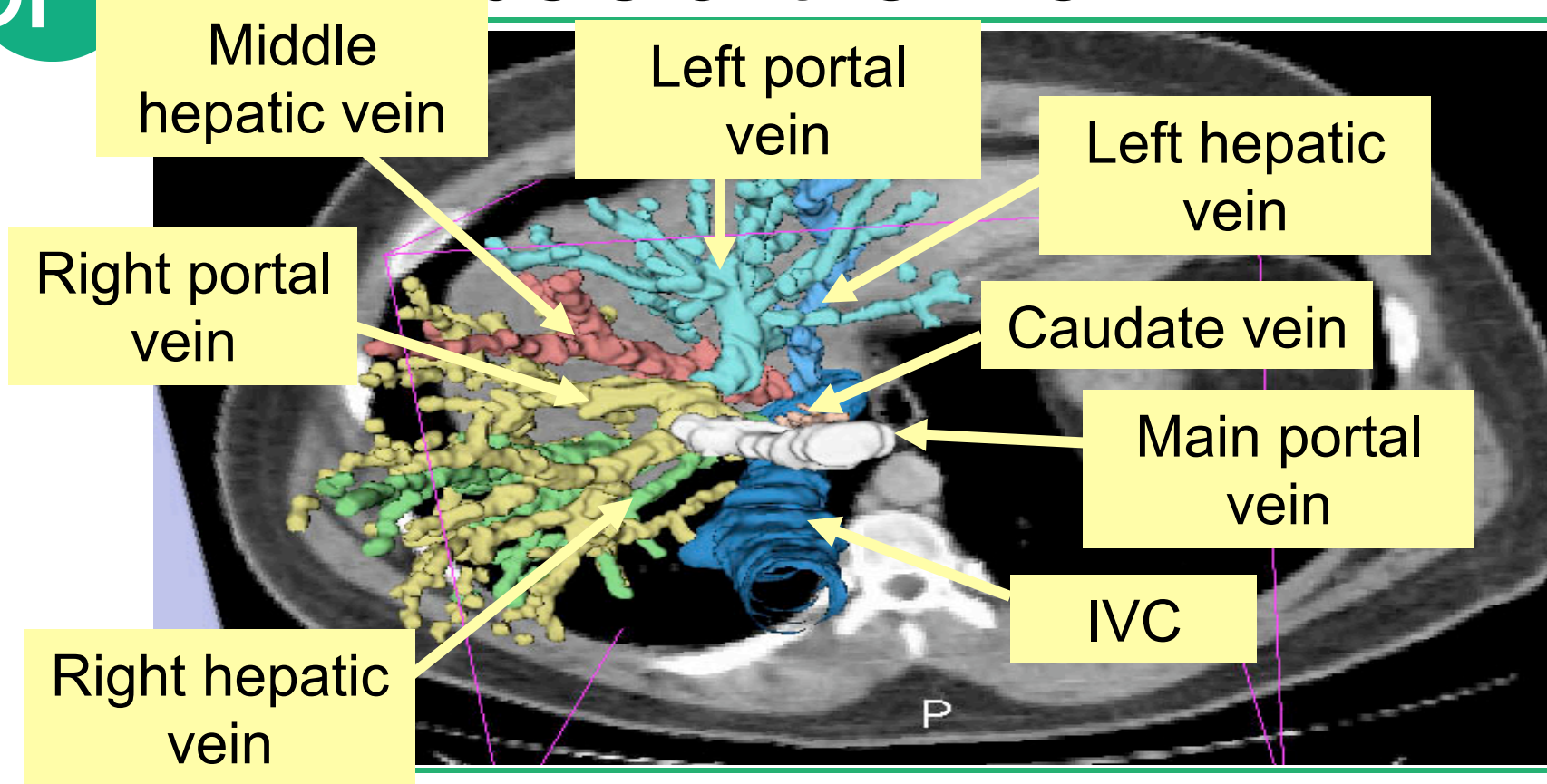



3D Exploration of Liver Segments

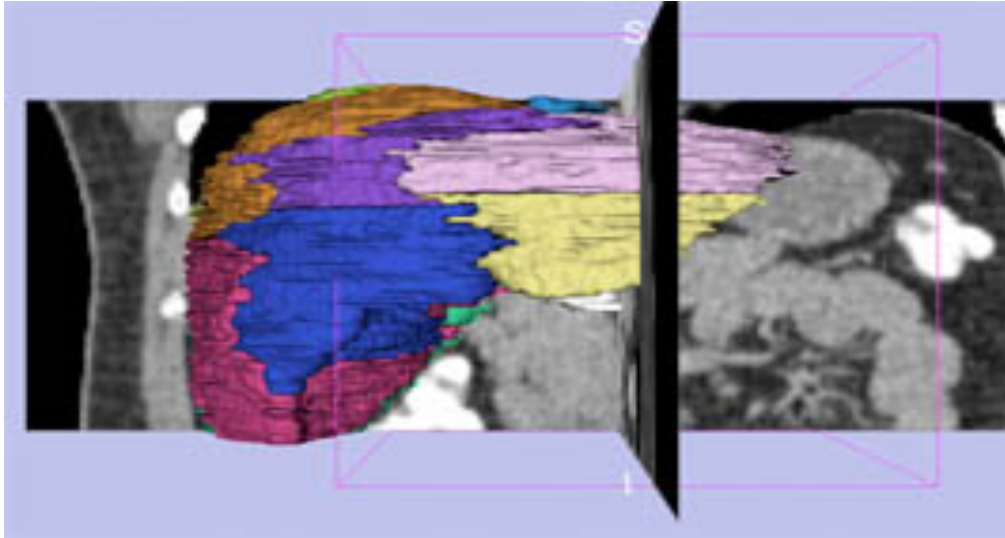

Example:

What organ abuts the left-most margin of segment II in this patient ?



3D Exploration of Liver Segments

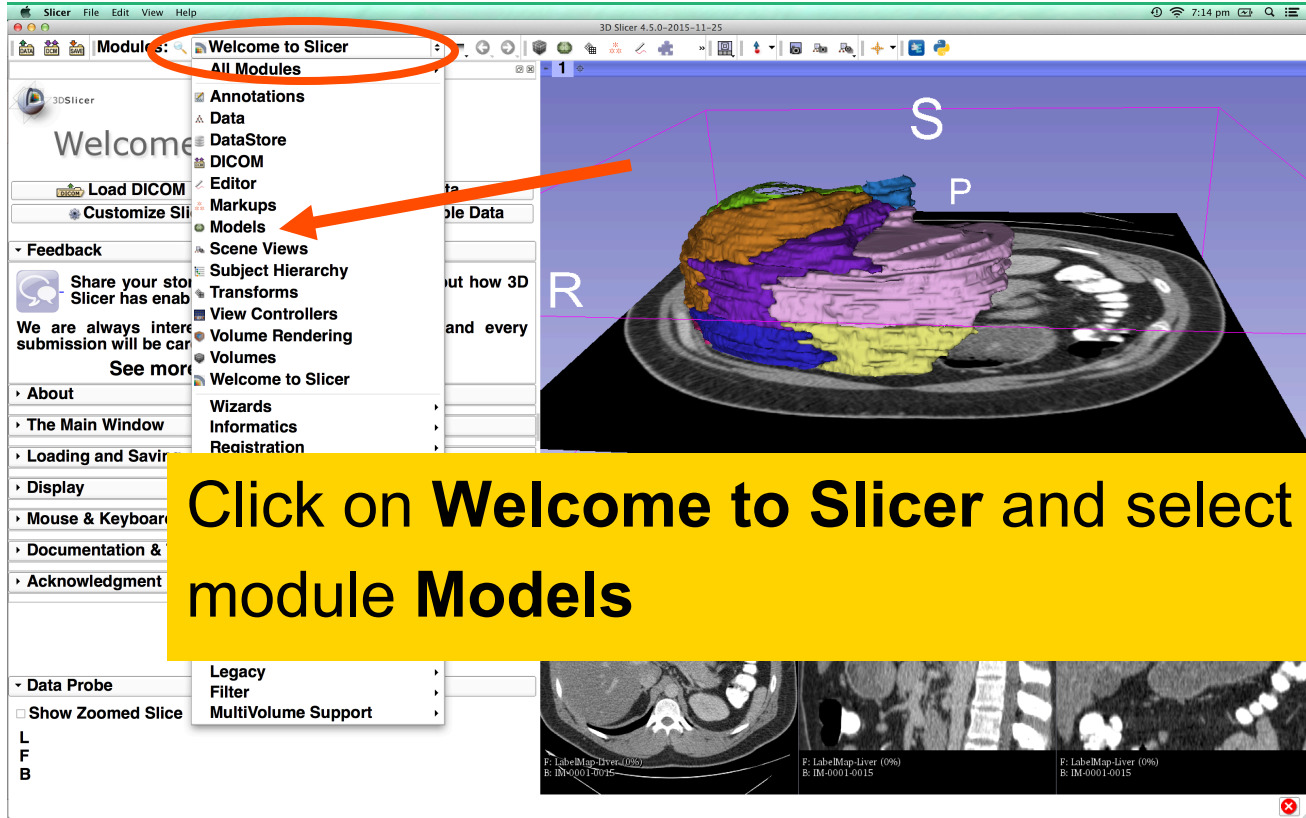



3D Exploration of Liver Segments

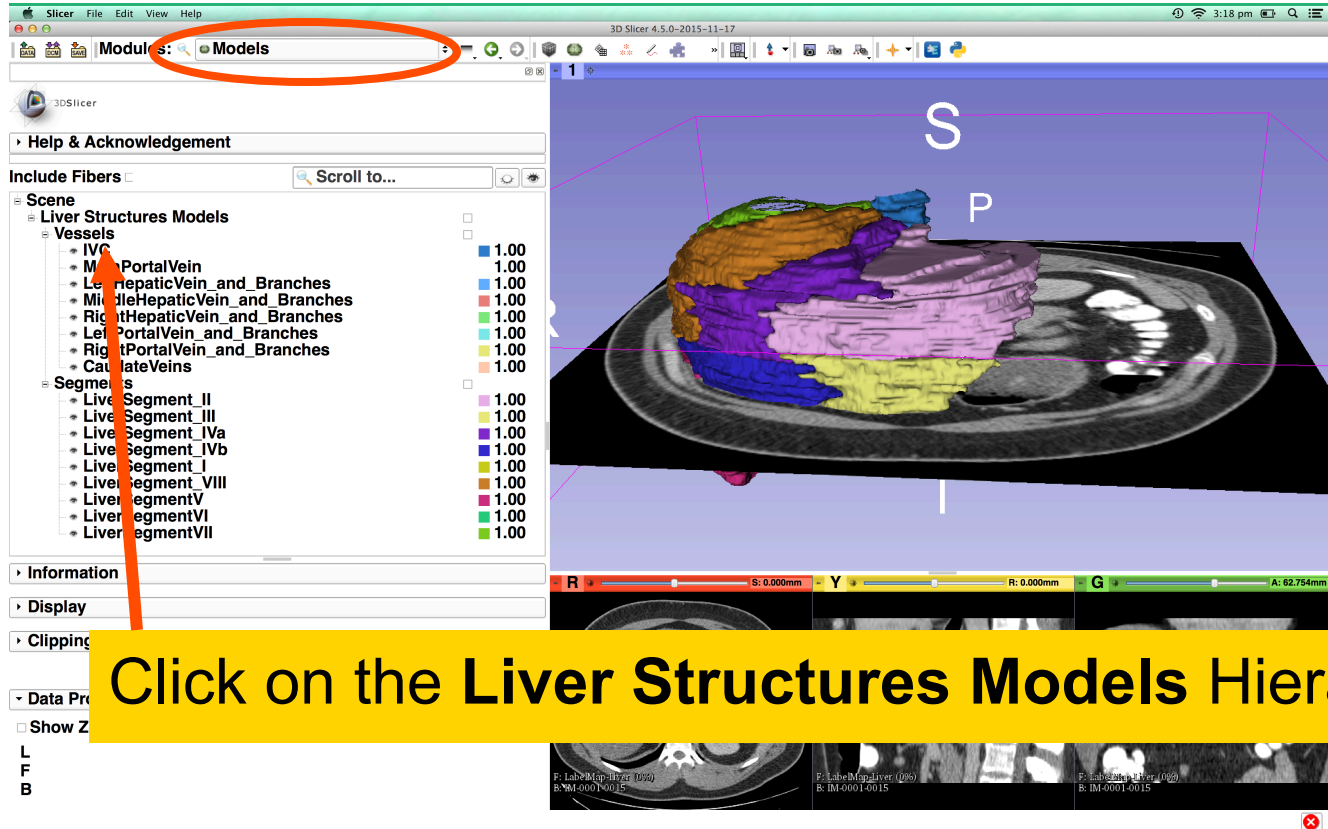



3D Exploration of Liver Segments

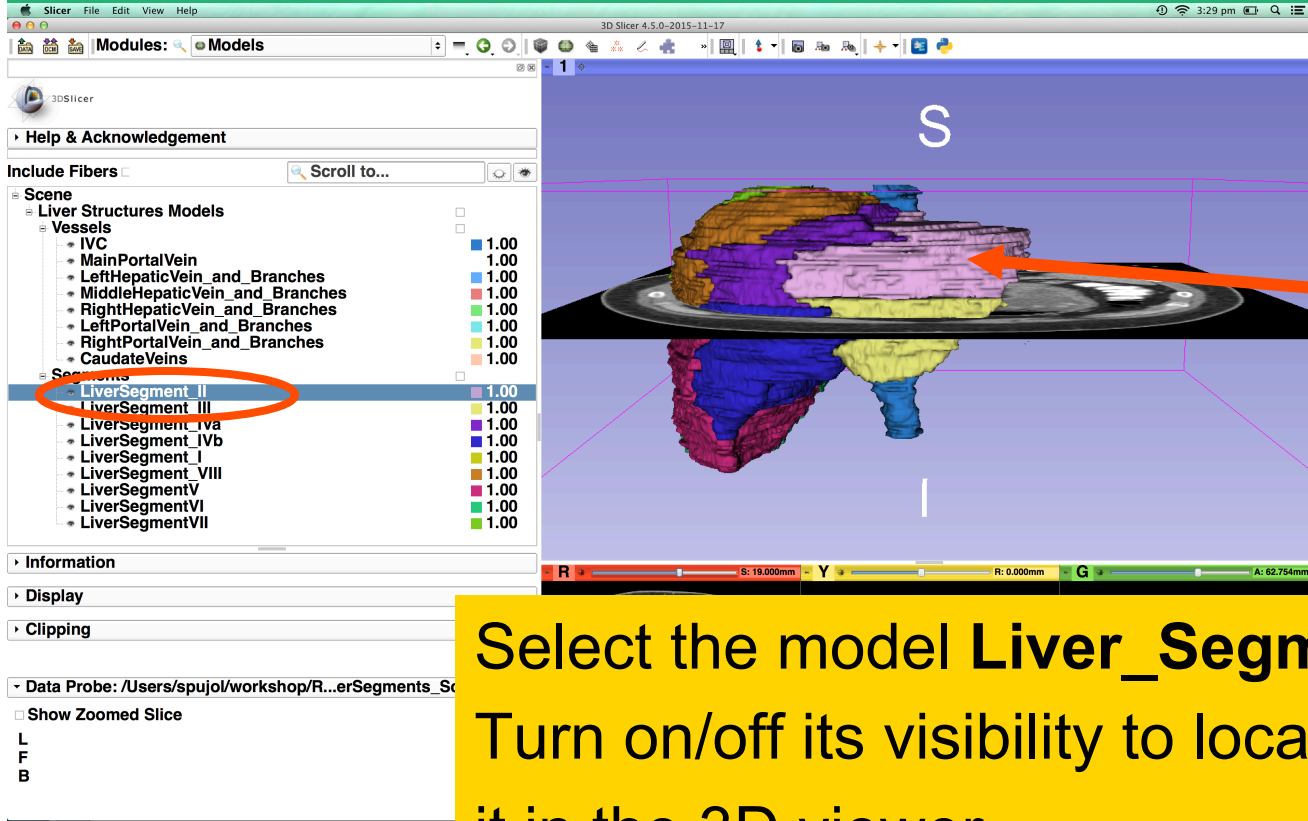



3D Exploration of Liver Segments

Position the mouse in the 3D Viewer, hold down the left mouse button and drag to orient the 3D model to a superior view.

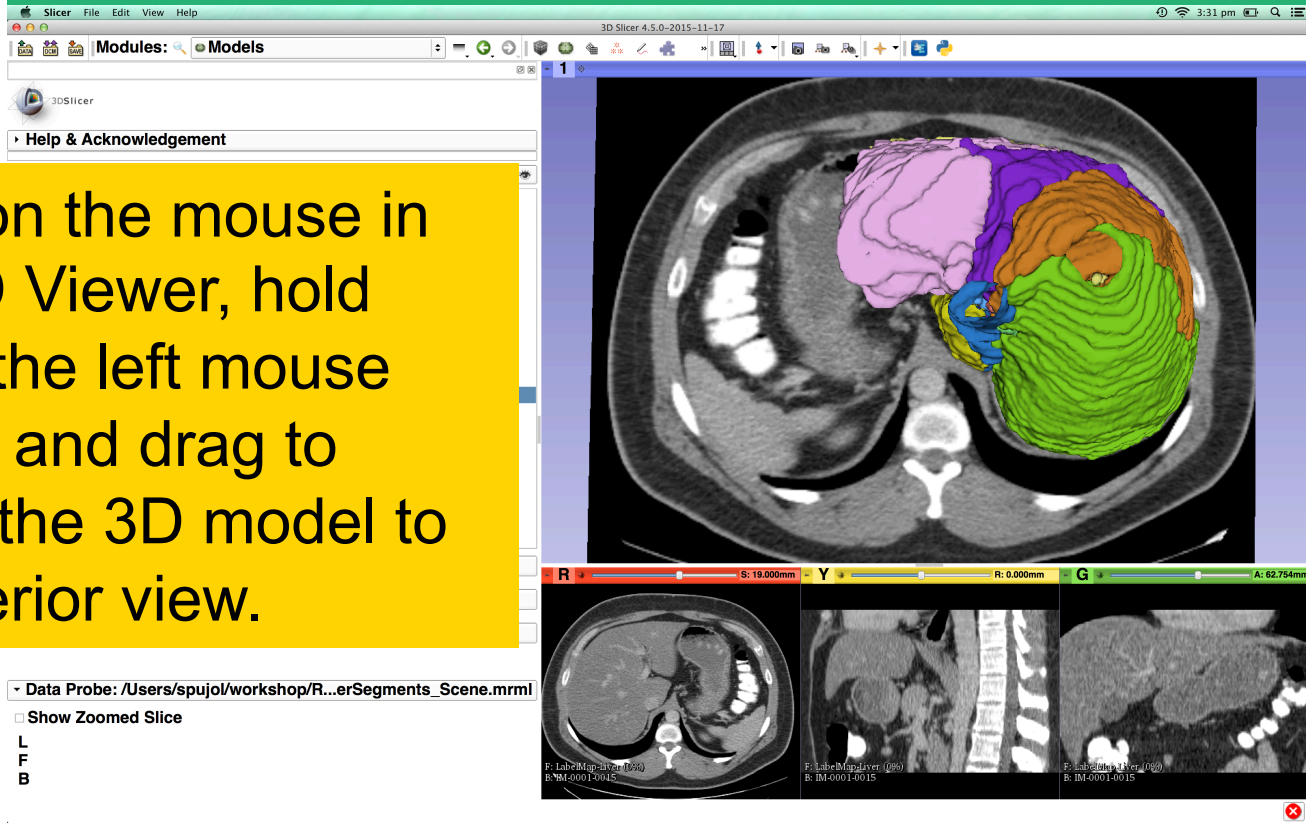



3D Exploration of Liver Segments

Question 1:

What organ abuts the left-most margin of segment II in Patient 1?

3D Slicer 4.5.0-2015-11-17

Modules: Models

1

Seg II

- LiverSegment_I 1.00
- LiverSegment_VIII 1.00
- LiverSegmentV 1.00
- LiverSegmentVI 1.00
- LiverSegmentVII 1.00

Information

Display

Clipping

Data Probe: /Users/spujol/workshop/R...erSegments_Scene.mrml

Show Zoomed Slice

L

F

B

R: 19.000mm Y: 0.000mm G: 62.754mm

F: LabelMapLiver (0%)
B: IM-0001-0015

F: LabelMapLiver (0%)
B: IM-0001-0015

F: LabelMapLiver (0%)
B: IM-0001-0015



3D Exploration of Liver Segments

Question 1:

What organ abuts the left-most margin of segment II in this patient?

Answer 1: Stomach

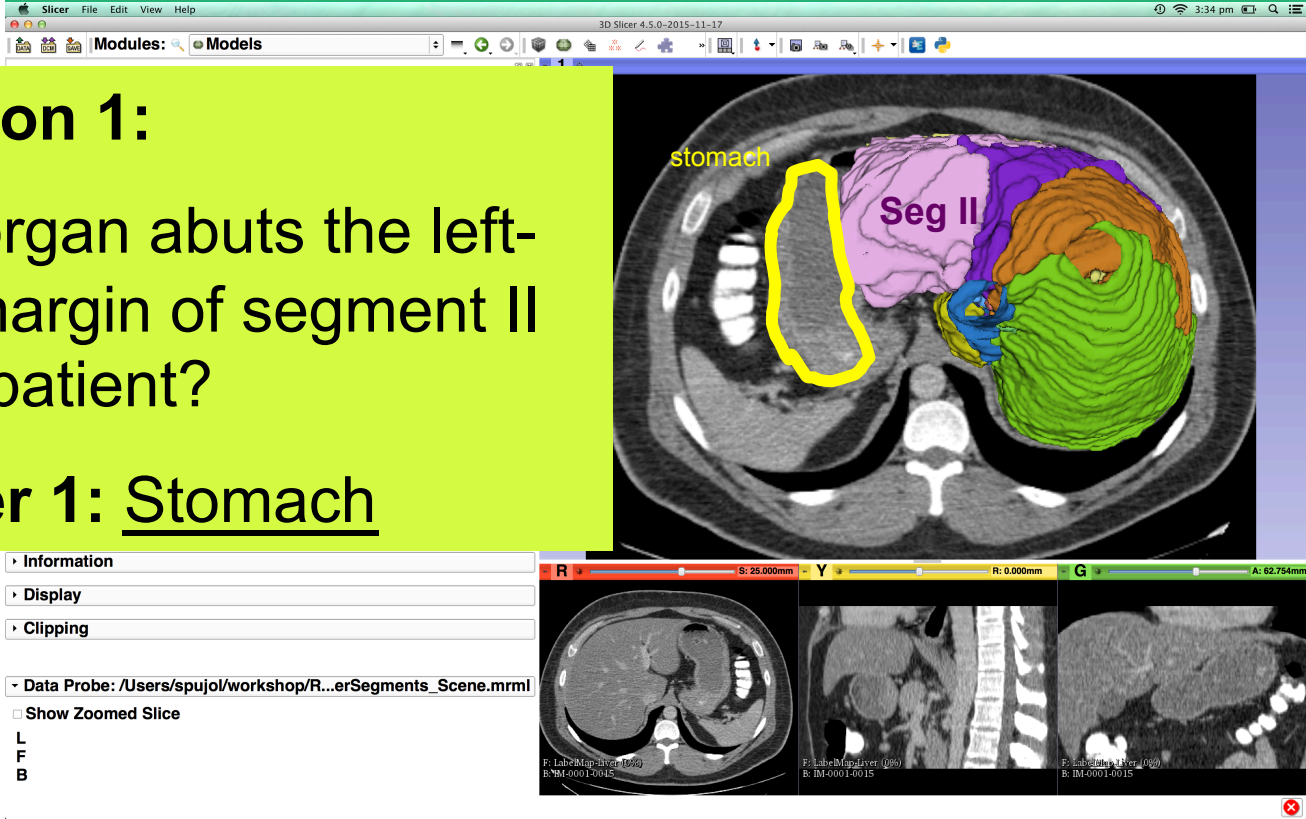



3D Exploration of Liver Segments

Question 2:

Which segment would most likely be affected by an aggressive tumor invading locally from the right adrenal gland ?

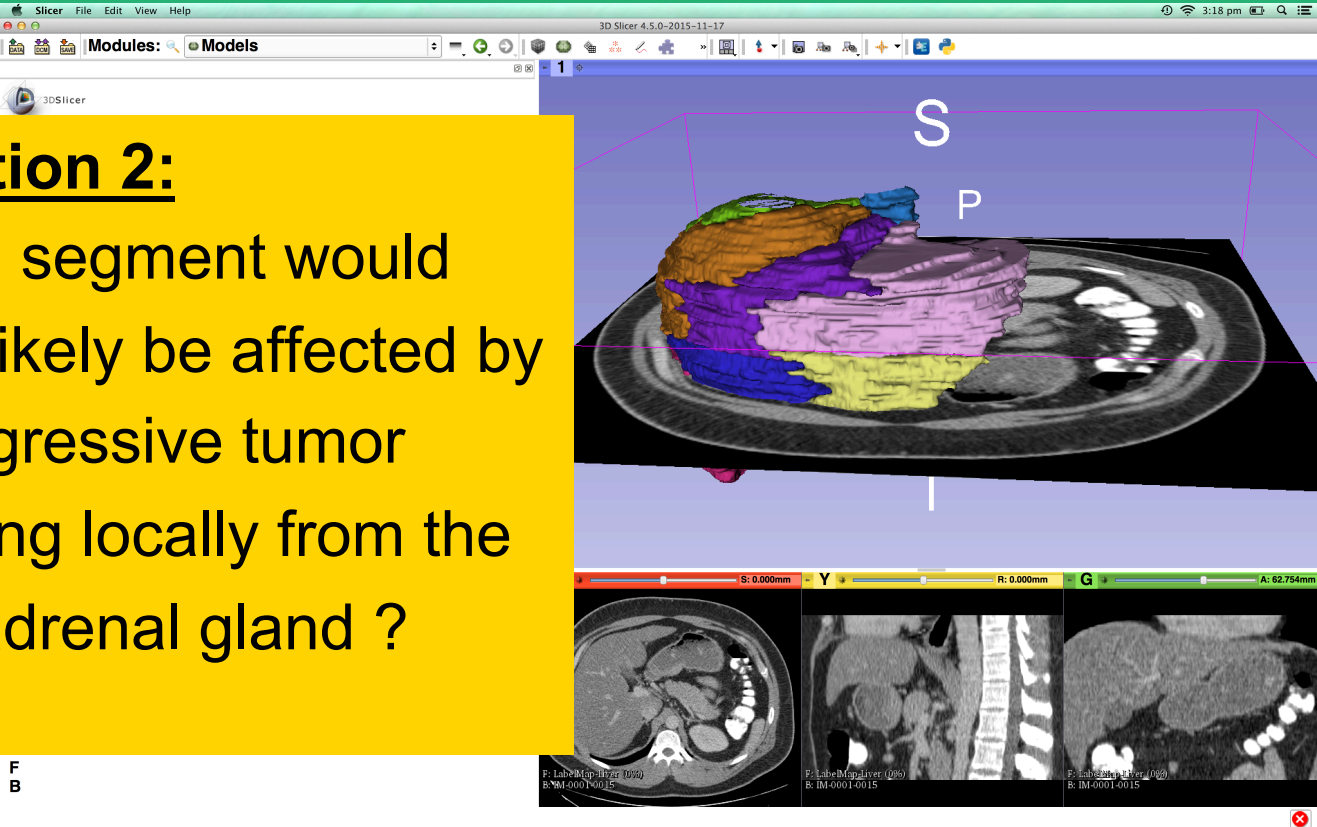

F
B



3D Exploration of Liver Segments

Question 2:

Which segment would most likely be affected by an aggressive tumor invading locally from the right adrenal gland ?

Answer 2: Segment VII

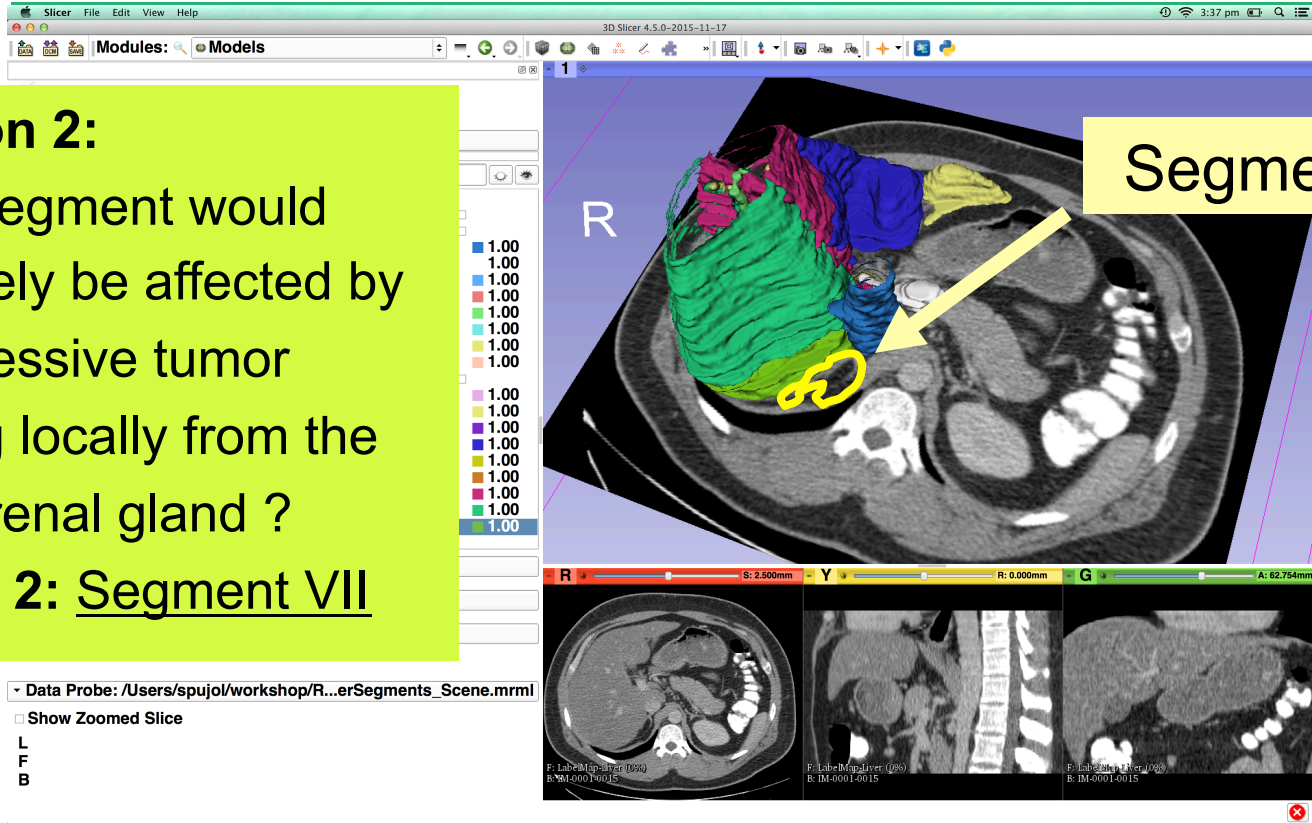



3D Exploration of Liver Segments



Question 3:

Which vessel separates Segment IVb and Segment V?



Middle Hepatic Vein

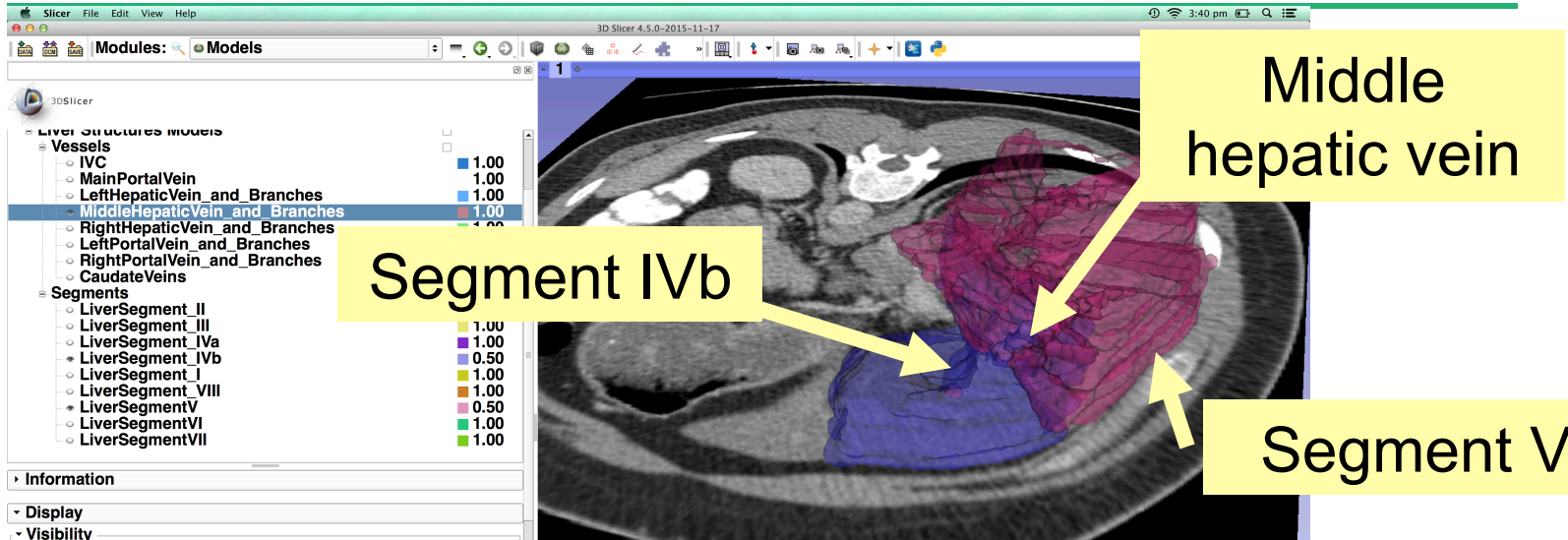

Question 3:

Which vessel separates Segment IVb and Segment V?

Answer 3: The middle hepatic vein



Closing the Liver Scene

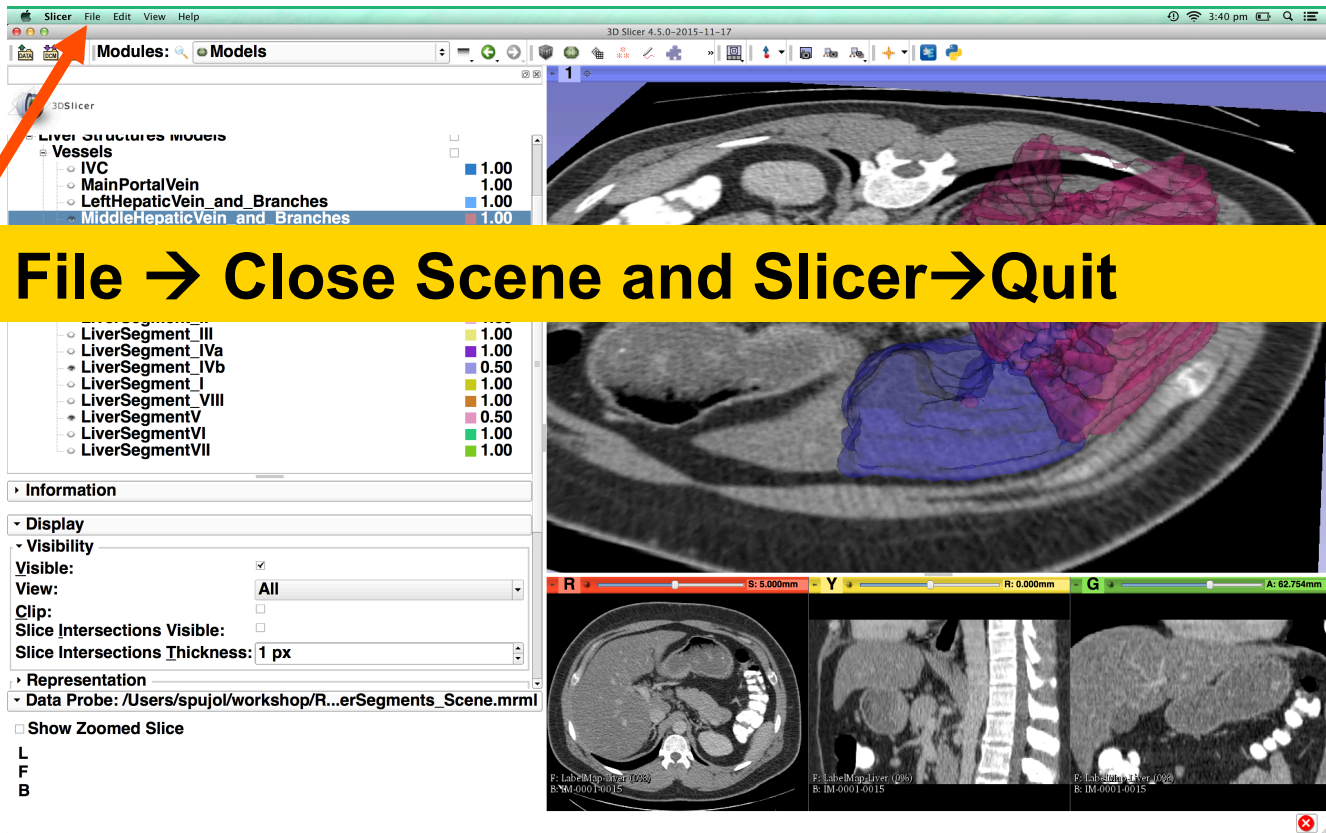

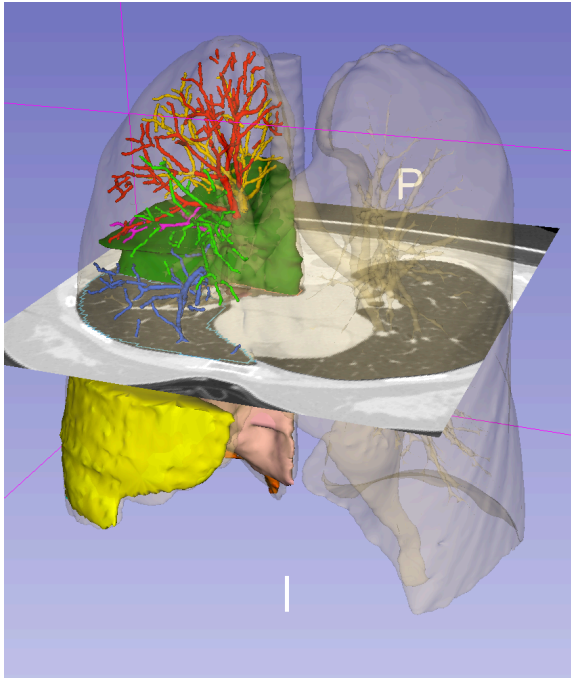

Part IIIb: Interactive 3D Visualization of the segments of the lungs



Segments of the lung

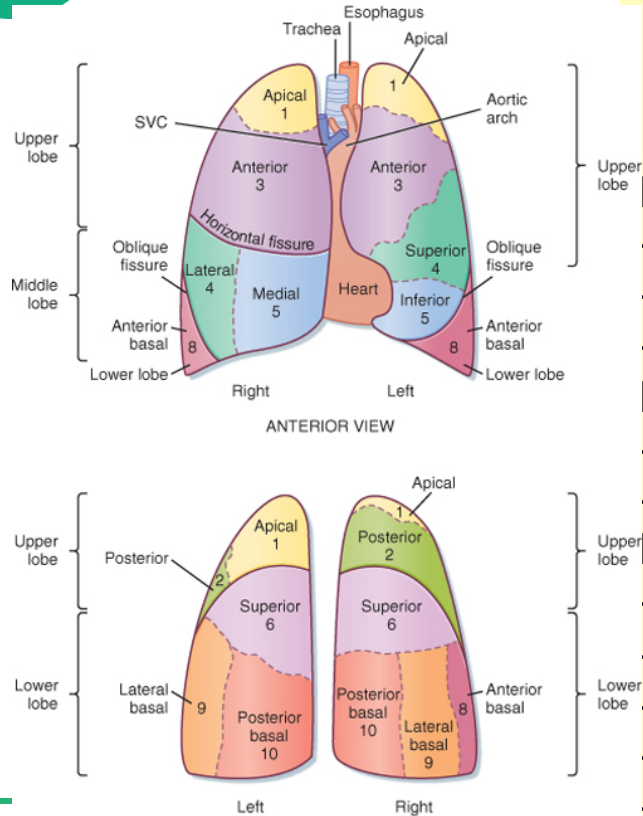

Right Lung (10 segments)

- Right Upper Lobe (RUL)
 - RUL Apical
 - RUL Posterior
 - RUL Anterior
- Right Middle Lobe (RML)
 - RML Lateral
 - RML Medial
- Right Lower Lobe (RLL)
 - RLL Superior
 - RLL Medial Basal
 - RLL Anterior Basal
 - RLL Lateral Basal
 - RLL Posterior Basal

Left Lung (8 segments)

- Left Upper Lobe (LUL)
 - LUL Apical Posterior
 - LUL Anterior
- Left Upper Lobe Lingula (LUL Lingula)
 - LUL Superior Lingula
 - LUL Inferior Lingula
- Left Lower Lobe (LLL)
 - LLL Superior
 - LLL Anteromedial Basal
 - LLL Lateral Basal
 - LLL Posterior Basal



Loading the Lung Scene

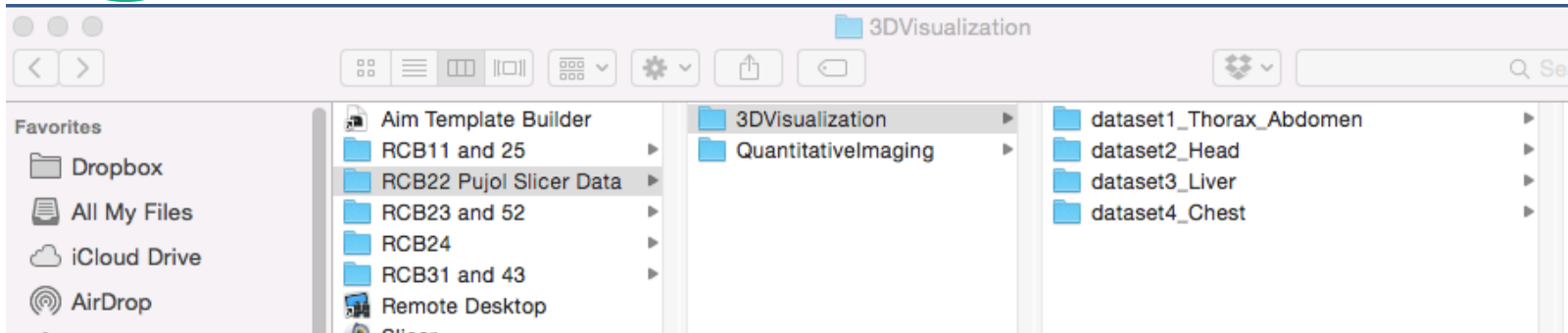

Browse to the directory **RCB22 Pujol Slicer Data**

Select the directory **3D Visualization**

Select the directory **dataset4_Chest**



Loading the Lung scene

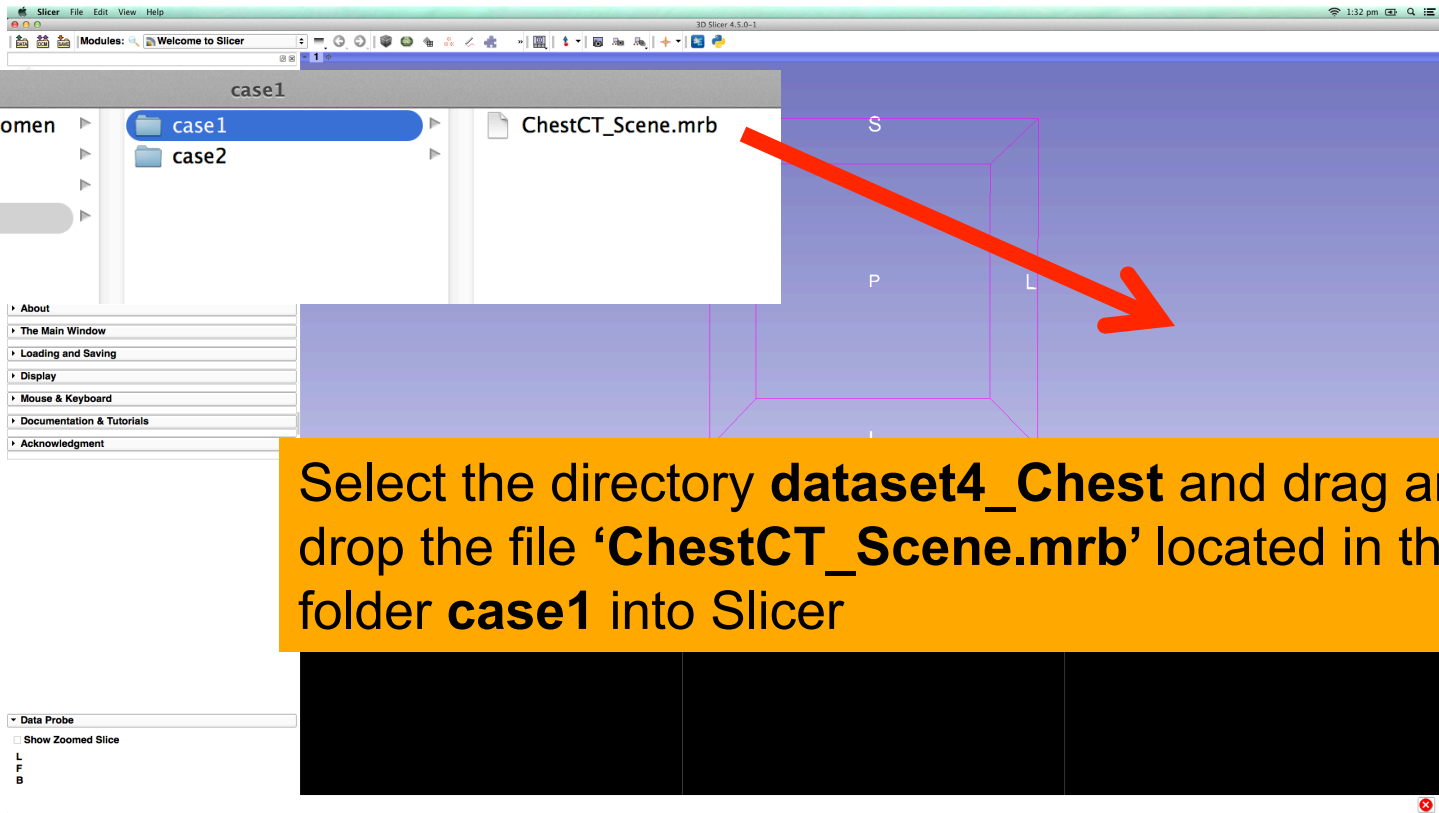

Select the directory **dataset4_Chest** and drag and drop the file '**ChestCT_Scene.mrb**' located in the folder **case1** into Slicer



Chest CT case 1

The screenshot shows the 3D Slicer 4.5.0-2015-11-17 interface. The main window displays a 3D model of a chest CT scan with a purple wireframe bounding box. A dialog box titled "Add data into the scene" is open, showing a table with the following content:

File	Description
...hest/case1/ChestCT_Scene.mrb	MRB Slicer Data Bundle

Buttons for "Reset", "OK", and "Cancel" are visible at the bottom of the dialog. The background interface includes a "Welcome" panel on the left with buttons for "Load DICOM Data", "Load Data", "Customize Slicer", and "Download Sample Data".

Click on OK to load the file into Slicer



Chest CT case 1

The screenshot shows the 3D Slicer 4.5.0-2015-11-17 interface. The 'Markups' module is selected in the 'Modules' menu, which is circled in red. The 'List' panel on the left shows a table of anatomical landmarks. The main view displays an axial CT scan of the chest with a red arrow pointing to the 'RML Lateral' landmark.

	Name	R	A	S
1	RUL Anterior	57.093	168.3...	-141.000
2	RML Medial	72.210	173.6...	-168.000
3	RLL Medial Basal	60.368	143.8...	-171.000
4	Q1	73.470	151.1...	-195.000
5	Q2	84.053	153.4...	-195.000
6	Q3	74.478	138.8...	-195.000
7	LLL Medial Basal	-32.101	133.3...	-159.000
8	LLL Posterior Basal	-45.707	132.3...	-189.000
9	RML Lateral	86.824	162.0...	-177.000
10	RUL Posterior	55.077	141.6...	-123.000
11	RUL Apical	58.353	155.4...	-120.000
12	RLL Superior	65.660	147.9...	-165.000
13	LUL Anterior	-45.707	190.0...	-150.000
14	LUL Apical Posterior	-28.069	157.2...	-138.000
15	LUL Superior Lingula	-56.037	169.5...	-180.000

Advanced
Data Probe: /Users/spujol/workshop/R...e1/ChestCT_Scene.mrml
Red RAS: (46.3, 180.3, -177.0) Axial Sp: 3.0
L None
F None
B2 Chest 3X3 Soft (213, 268, 59)109

Select the **Markups** module from the Modules menu



Chest CT case 1

3D Slicer 4.5.0-2015-11-17

Markups

3DSlicer

Help & Acknowledgement

List Artery

Scale 3.00

Click to Jump Slices

Offset Centered Show Slice Intersections

Transformed Hide RAS

		Name	R	A	S
1	<input checked="" type="checkbox"/>	RUL Anterior	57.093	168.3...	-141.000
2	<input checked="" type="checkbox"/>	RML Medial	72.210	173.6...	-168.000
3	<input checked="" type="checkbox"/>	RLL Medial Basal	60.368	143.8...	-171.000
4	<input checked="" type="checkbox"/>	Q1	73.470	151.1...	-195.000
5	<input checked="" type="checkbox"/>	Q2	84.053	153.4...	-195.000
6	<input checked="" type="checkbox"/>	Q3	74.478	138.8...	-195.000
7	<input checked="" type="checkbox"/>	LLL Medial Basal	-32.101	133.3...	-159.000
8	<input checked="" type="checkbox"/>	LLL Posterior Basal	-45.707	132.3...	-189.000
9	<input checked="" type="checkbox"/>	RML Lateral	86.824	162.0...	-177.000
10	<input checked="" type="checkbox"/>	RUL Posterior	55.077	141.6...	-123.000
11	<input checked="" type="checkbox"/>	RUL Apical	58.353	155.4...	-120.000
12	<input checked="" type="checkbox"/>	RLL Superior	65.660	147.9...	-165.000
13	<input checked="" type="checkbox"/>	LUL Anterior	-45.707	190.0...	-150.000
14	<input checked="" type="checkbox"/>	LUL Apical Posterior	-28.069	157.2...	-138.000
15	<input checked="" type="checkbox"/>	LUL Superior Lingula	-56.037	169.5...	-180.000

Advanced

Data Probe: /Users/spujol/workshop/R...e1/ChestCT_Scene.mrml

Red RAS: (46.3, 180.3, -177.0) Axial Sp: 3.0

L None

F None

B2 Chest 3X3 Soft (213, 268, 59)109

Slicer displays the list of annotated segments in the GUI of the Markups module



Chest CT case 1

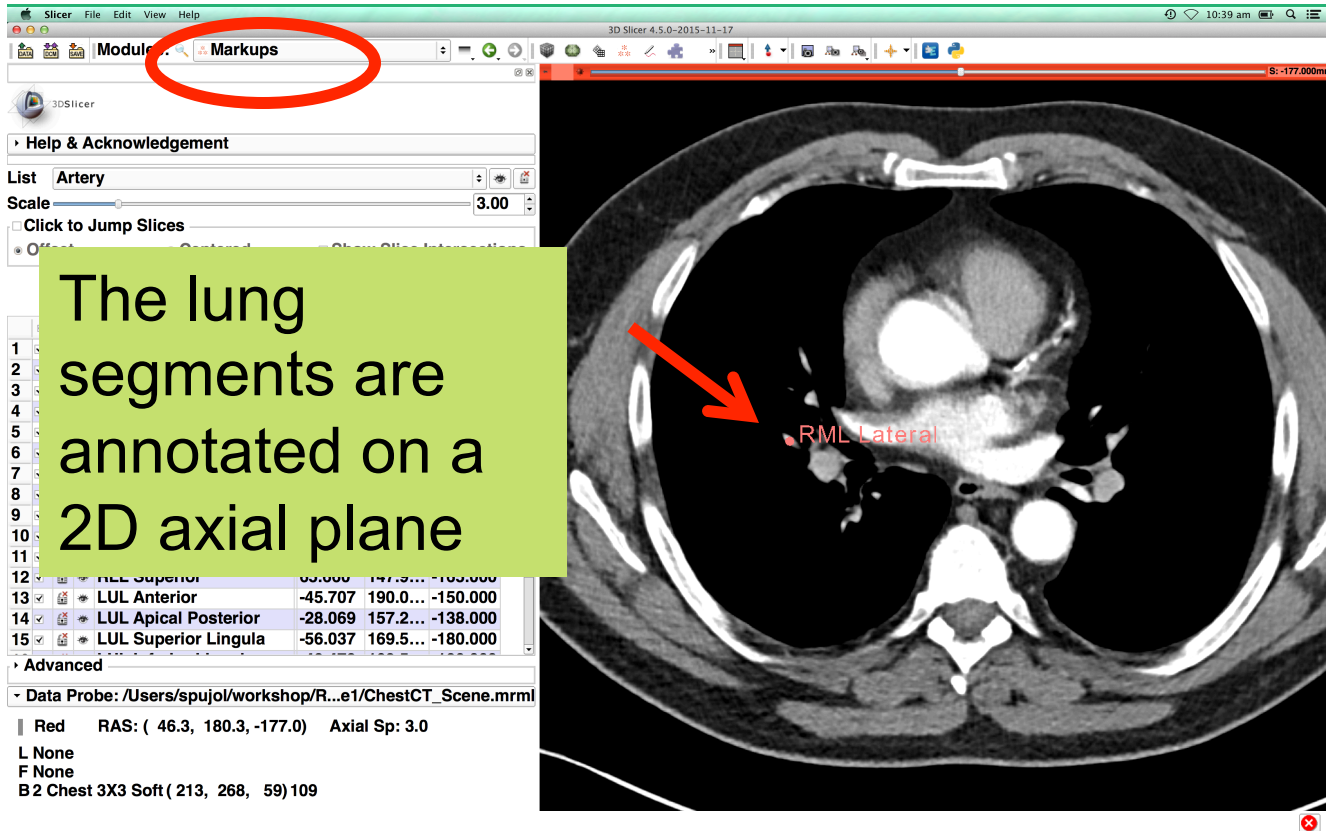



Chest CT case 1

The screenshot shows the 3D Slicer interface. The 'Markups' module is selected in the top toolbar. The main view displays an axial CT slice of the chest with a red arrow pointing to a structure labeled 'RML Lateral'. The left sidebar contains a list of structures with their bounding boxes:

8	✓	LLL Posterior Basal	-45.707	132.3...	-189.000
9	✓	RML Lateral	86.824	162.0...	-177.000
10	✓	RUL Posterior	55.077	141.6...	-123.000
11	✓	RUL Apical	58.353	155.4...	-120.000
12	✓	RLL Superior	65.660	147.9...	-165.000
13	✓	LUL Anterior	-45.707	190.0...	-150.000
14	✓	LUL Apical Posterior	-28.069	157.2...	-138.000
15	✓	LUL Superior Lingula	-56.037	169.5...	-180.000

Below the list, the 'Advanced' section shows the data probe path and rendering options:

Advanced
Data Probe: /Users/spujol/workshop/R...e1/ChestCT_Scene.mrml
Red RAS: (46.3, 180.3, -177.0) Axial Sp: 3.0
L None
F None
B2 Chest 3X3 Soft (213, 268, 59)109

Browse through the slices to explore the annotated structures



Chest CT case 1

Question 1: Which segments are Q1, Q2 and Q3?

3D Slicer 4.5.0-2015-11-17

Modules: Markups

3DSlicer

Help & Acknowledgement

List Artery

7	✓	LLL Medial Basal	-32.101	133.3...	-159.000
8	✓	LLL Posterior Basal	-45.707	132.3...	-189.000
9	✓	RML Lateral	86.824	162.0...	-177.000
10	✓	RUL Posterior	55.077	141.6...	-123.000
11	✓	RUL Apical	58.353	155.4...	-120.000
12	✓	RLL Superior	65.660	147.9...	-165.000
13	✓	LUL Anterior	-45.707	190.0...	-150.000
14	✓	LUL Apical Posterior	-28.069	157.2...	-138.000
15	✓	LUL Superior Lingula	-56.037	169.5...	-180.000
16	✓	LUL Inferior Lingula	48.478	169.5...	-180.000

Advanced

Data Probe: /Users/spujol/workshop/R...e1/ChestCT_Scene.mrml

Show Zoomed Slice

L
F
B



Chest CT case 1

3D Slicer 4.5.0-2015-11-17

Modules: Markups

3DSlicer

Help & Acknowledgement

List Artery

Scale 3.00

Click to Jump Slices

Offset Centered Show Slice Intersections

Transformed Hide RAS

		Name	R	A	S
1	<input checked="" type="checkbox"/>	RUL Anterior	57.093	168.3...	-141.000
2	<input checked="" type="checkbox"/>	RML Medial	72.210	173.6...	-168.000
3	<input checked="" type="checkbox"/>	RLL Medial Basal	60.368	143.8...	-171.000
4	<input checked="" type="checkbox"/>	Q1	73.470	151.1...	-195.000
5	<input checked="" type="checkbox"/>	Q2	84.053	153.4...	-195.000
6	<input checked="" type="checkbox"/>	Q3	74.478	138.8...	-195.000
7	<input checked="" type="checkbox"/>	LLL Medial Basal	-32.101	133.3...	-159.000
8	<input checked="" type="checkbox"/>	LLL Posterior Basal	-45.707	132.3...	-189.000
9	<input checked="" type="checkbox"/>	RML Lateral	86.824	162.0...	-177.000
10	<input checked="" type="checkbox"/>	RUL Posterior	55.077	141.6...	-123.000
11	<input checked="" type="checkbox"/>	RUL Apical	58.353	155.4...	-120.000
12	<input checked="" type="checkbox"/>	RLL Superior	65.660	147.9...	-165.000
13	<input checked="" type="checkbox"/>	LUL Anterior	-45.707	190.0...	-150.000
14	<input checked="" type="checkbox"/>	LUL Apical Posterior	-28.069	157.2...	-138.000
15	<input checked="" type="checkbox"/>	LUL Superior Lingula	-56.037	169.5...	-180.000
16	<input checked="" type="checkbox"/>	LUL Inferior Lingula	48.478	169.5...	-180.000

Advanced

Data Probe: /Users/spujol/workshop/R...e1/ChestCT_Scene.mrml

Show Zoomed Slice

L
F
I

Answer 1

Q1: Right Lower Lobe

(RLL) anterior basal

Q2: RLL lateral basal

Q3: RLL posterior basal



Chest CT case 1

3D Slicer 4.5.0-2015-11-17

Modules: Markups

3DSlicer

Help & Acknowledgement

List Artery

Scale 3.00

Click to Jump Slices

Offset Centered Show Slice Intersections

Transformed Hide RAS

	Name	R	A	S
1	RUL Anterior	57.002	168.2	141.000
2	RML Medial			
3	RLL Medial B			
4	Q1			
5	Q2			
6	Q3	74.478	138.8...	-195.000
7	LLL Medial Basal	-32.101	133.3...	-159.000
8	LLL Posterior Basal	-45.707	132.3...	-189.000
9	RML Lateral	86.824	162.0...	-177.000
10	RUL Posterior	55.077	141.6...	-123.000
11	RUL Apical	58.353	155.4...	-120.000
12	RLL Superior	65.660	147.9...	-165.000
13	LUL Anterior	-45.707	190.0...	-150.000
14	LUL Apical Posterior	-28.069	157.2...	-138.000
15	LUL Superior Lingula	-56.037	169.5...	-180.000
16	LUL Inferior Lingula	48.478	168.5	180.000

Advanced

Data Probe: /Users/spujol/workshop/R...e1/ChestCT_Scene.mrml

Show Zoomed Slice

L
F
I

Select File → Close Scene

Q2 Q1
Q3



Loading the Lung Scene

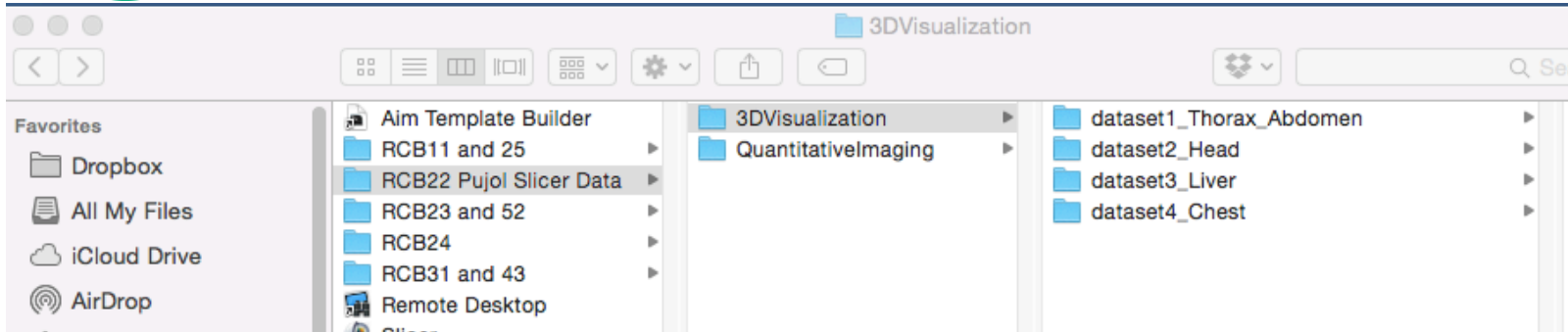

Browse to the directory **RCB22 Pujol Slicer Data**

Select the directory **3D Visualization**

Select the directory **dataset4_Chest**

Loading the Lung scene

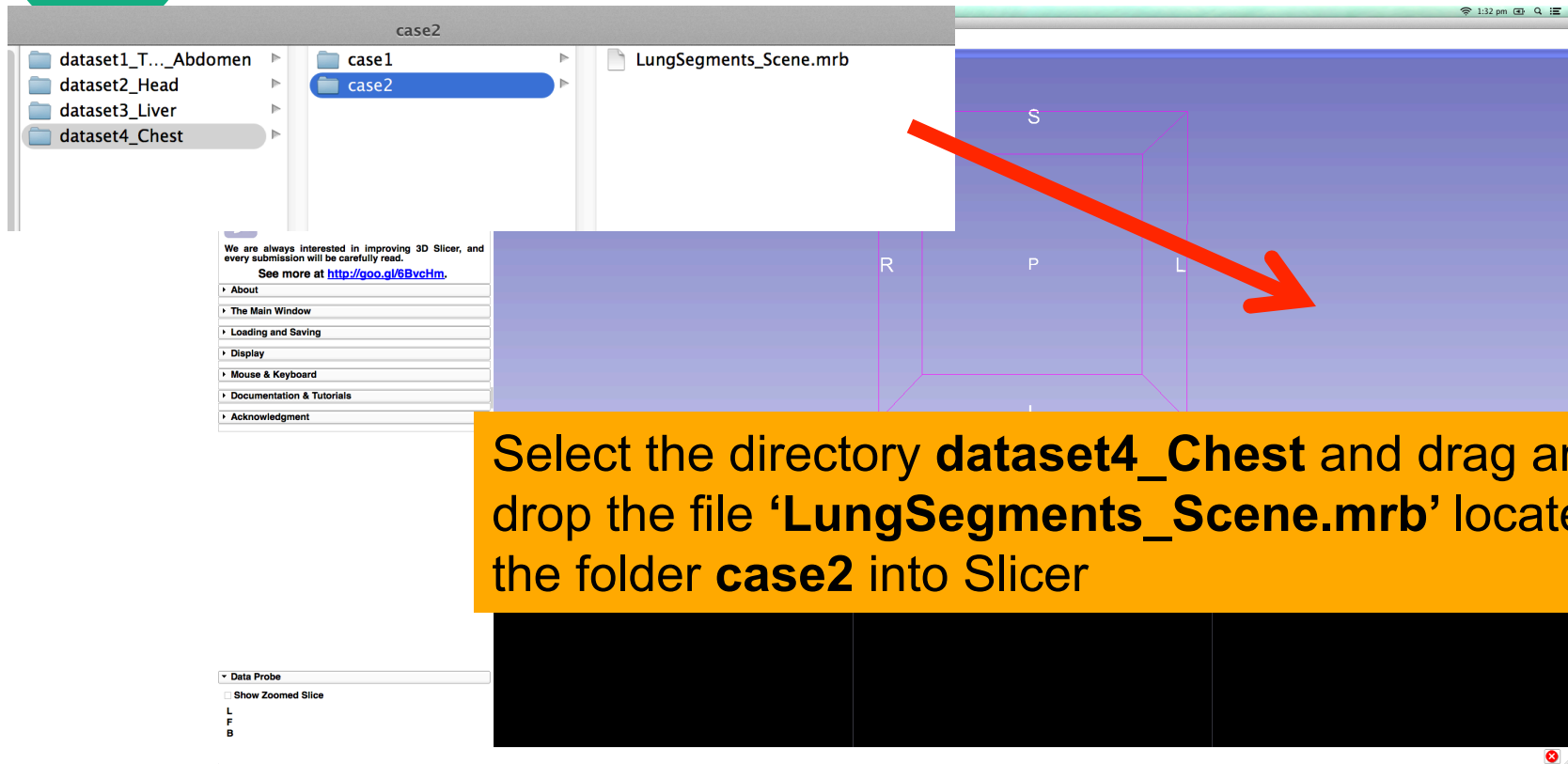



Chest CT case 2

The screenshot shows the 3D Slicer software interface. A dialog box titled "Add data into the scene" is open, displaying a table of files to be added. The table has two columns: "File" and "Description". One file is selected: "...tion_RSNA2015/dataset4_Chest/case2/LungSegments_Scene.mrb" with the description "MRB Slicer Data Bundle :". The dialog box has "Reset", "OK", and "Cancel" buttons at the bottom.

File	Description
...tion_RSNA2015/dataset4_Chest/case2/LungSegments_Scene.mrb	MRB Slicer Data Bundle :

Click on OK to load LungSegments_Scene.mrb to Slicer



Chest CT case 2

Select the module Models

3DSlicer

Welcome

Load DICOM Data Load Data

Customize Slicer Download Sample Data

Feedback

Share your stories with us and let us know about how 3D Slicer has enabled your research.

We are always interested in improving 3D Slicer, and every submission will be carefully read.

See more at <http://goo.gl/6BvchM>.

About

The Main Window

Loading and Saving

Display

Mouse & Keyboard

Documentation & Tutorials

Acknowledgment

Data Probe: /Users/spujol/workshop/R...ngSegments_Scene.mrml

Show Zoomed Slice

L
F
B

S
R
L
I

S: -137.250mm R: 3.452mm A: -43.146mm

L: chestCT_r...21 (100%) I: chestCT_r...2 (100%) C: chestCT_r...2 (100%)



Chest CT case 2

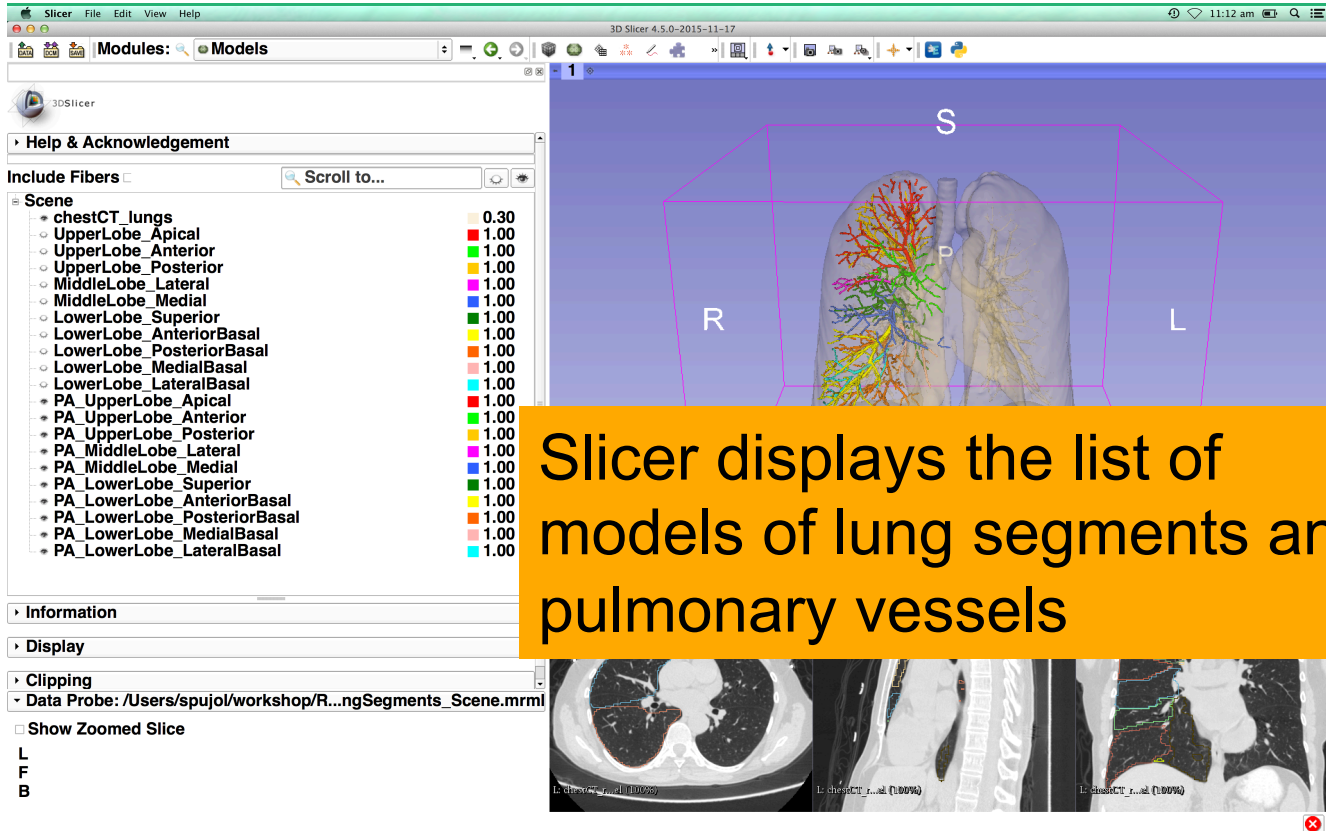



Lung Segments

Question 1: Why is there a gap in the vessels at the arrows?

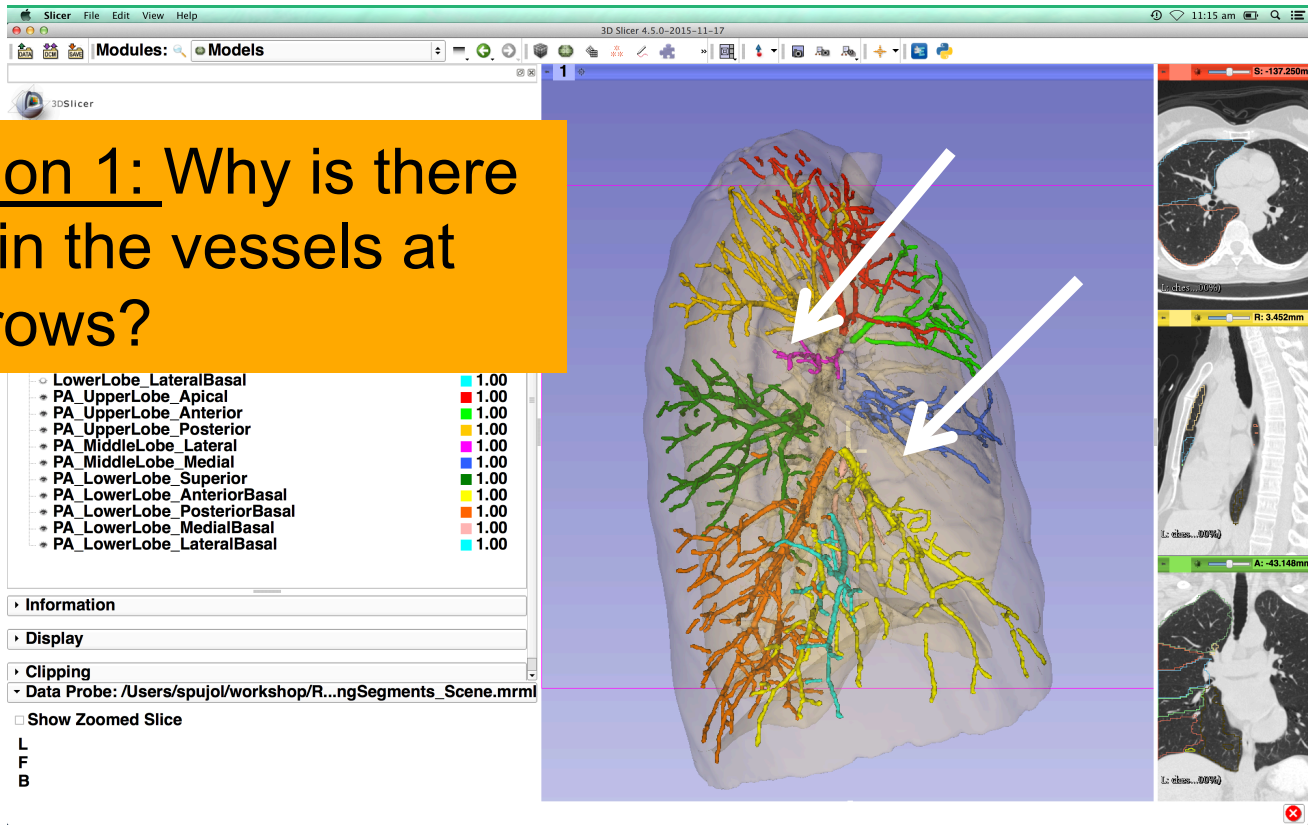



Lung Segments

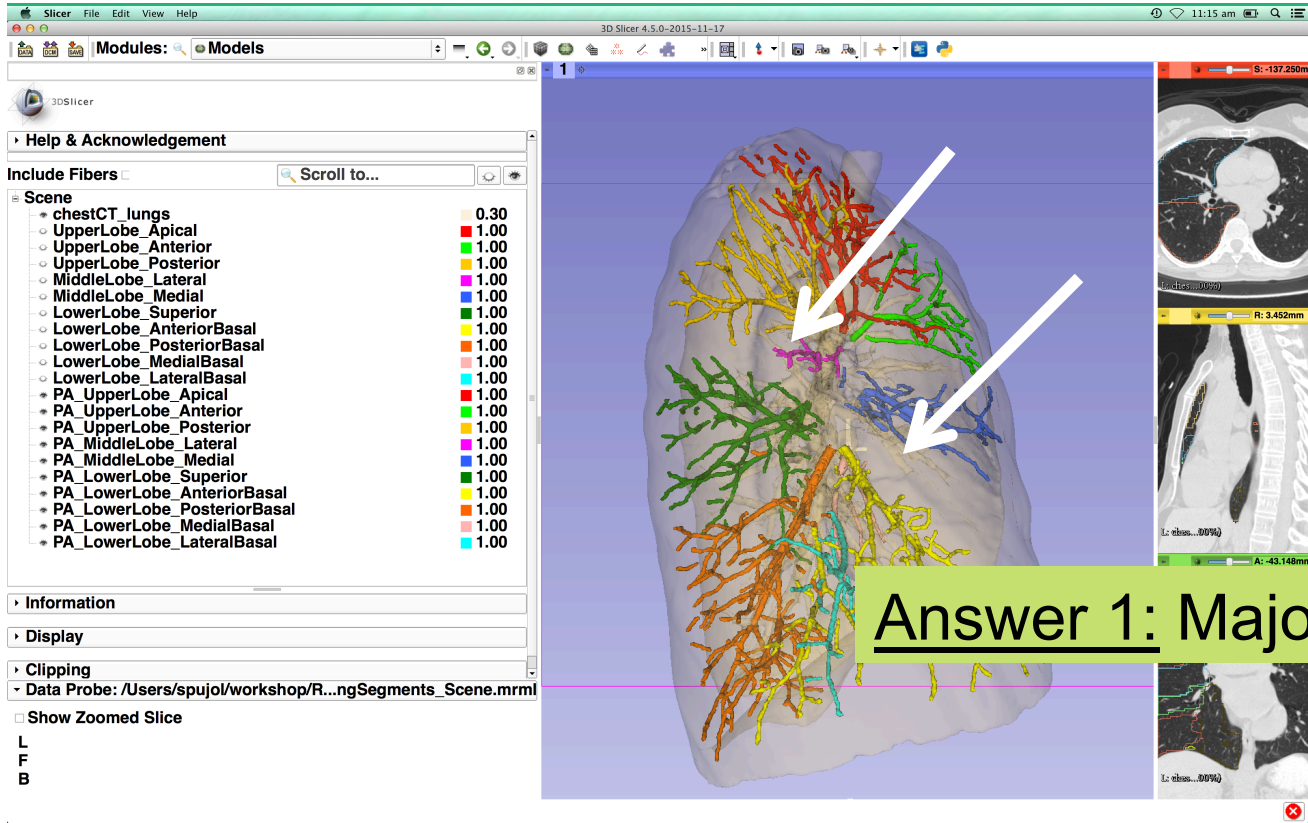



Lung Segments

Question 2: Classify the segments of the lower lobe by size

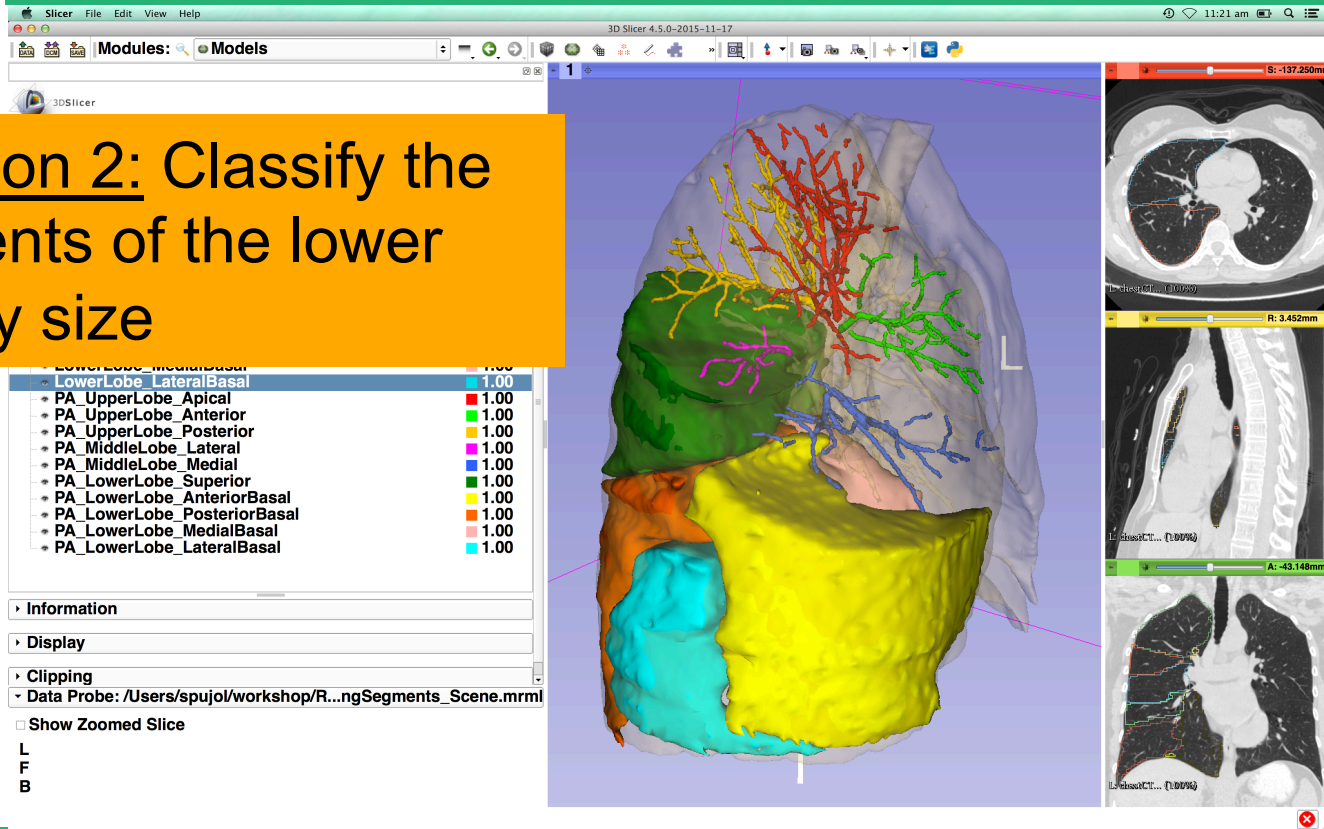



Chest CT case 2

3D Slicer 4.5.0-2015-11-17

Modules: Models

3DSlicer

Help & Acknowledgement

Include Fibers Scroll to...

Scene

- chestCT_lungs 0.30
- UpperLobe_Apical 1.00
- UpperLobe_Anterior 1.00
- UpperLobe_Posterior 1.00
- MiddleLobe_Lateral 1.00
- MiddleLobe_Medial 1.00
- LowerLobe_Superior 1.00
- LowerLobe_AnteriorBasal 1.00
- LowerLobe_PosteriorBasal 1.00
- LowerLobe_MedialBasal 1.00**
- LowerLobe_LateralBasal 1.00
- PA_UpperLobe_Apical 1.00
- PA_UpperLobe_Anterior 1.00
- PA_UpperLobe_Posterior 1.00
- PA_MiddleLobe_Lateral 1.00
- PA_MiddleLobe_Medial 1.00
- PA_LowerLobe_Superior 1.00
- PA_LowerLobe_AnteriorBasal 1.00
- PA_LowerLobe_PosteriorBasal 1.00
- PA_LowerLobe_MedialBasal 1.00
- PA_LowerLobe_LateralBasal 1.00

Information

Display

Clipping

Data Probe: /Users/spujol/workshop/R...ngSegments_Scene.mrml

Show Zoomed Slice

L
F
B

S-137.250mm
R: 3.452mm
A: -43.148mm

Answer 2a:
Smallest: Lower Lobe Medial Basal



Chest CT case 2

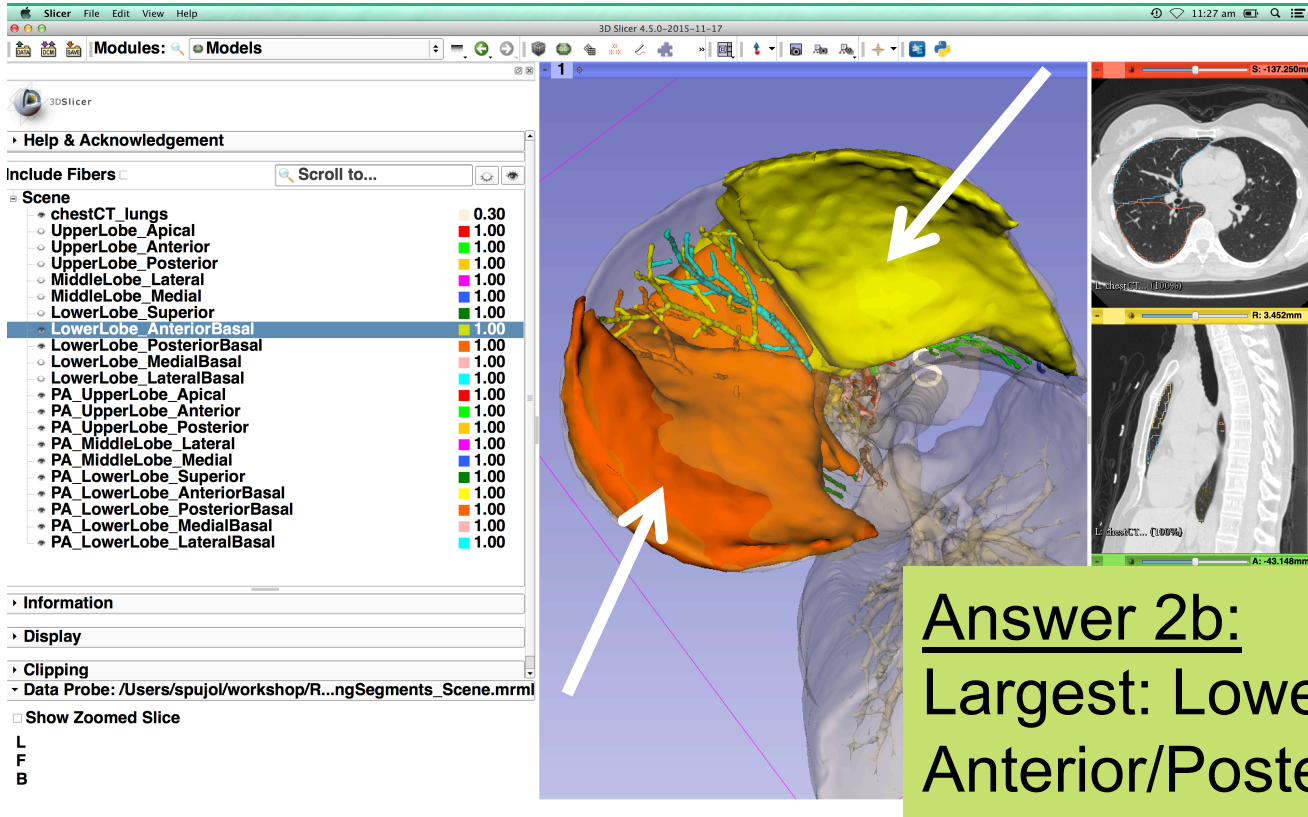



Lung Segments

Question 3: Which segment would most likely be damaged by a fracture of the right posterolateral 2nd rib?

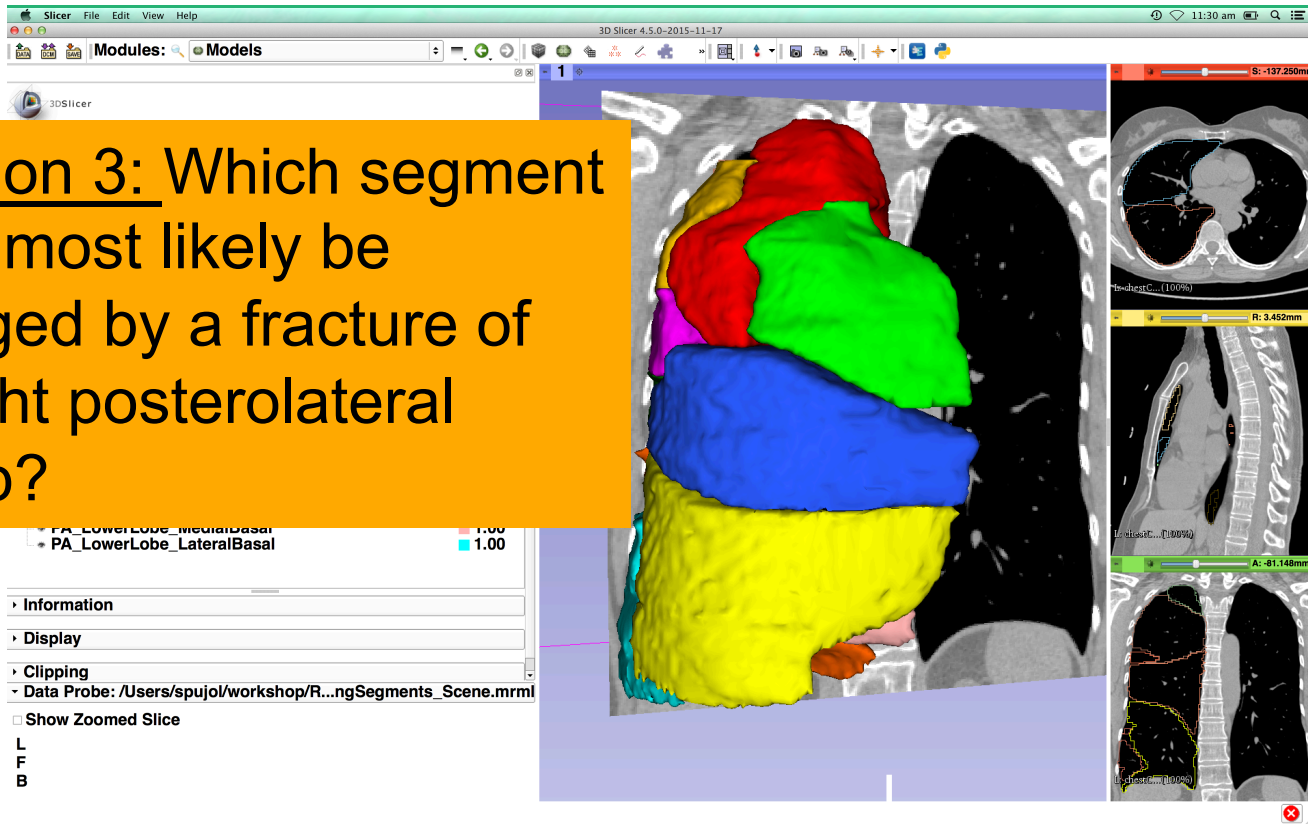



Lung Segments

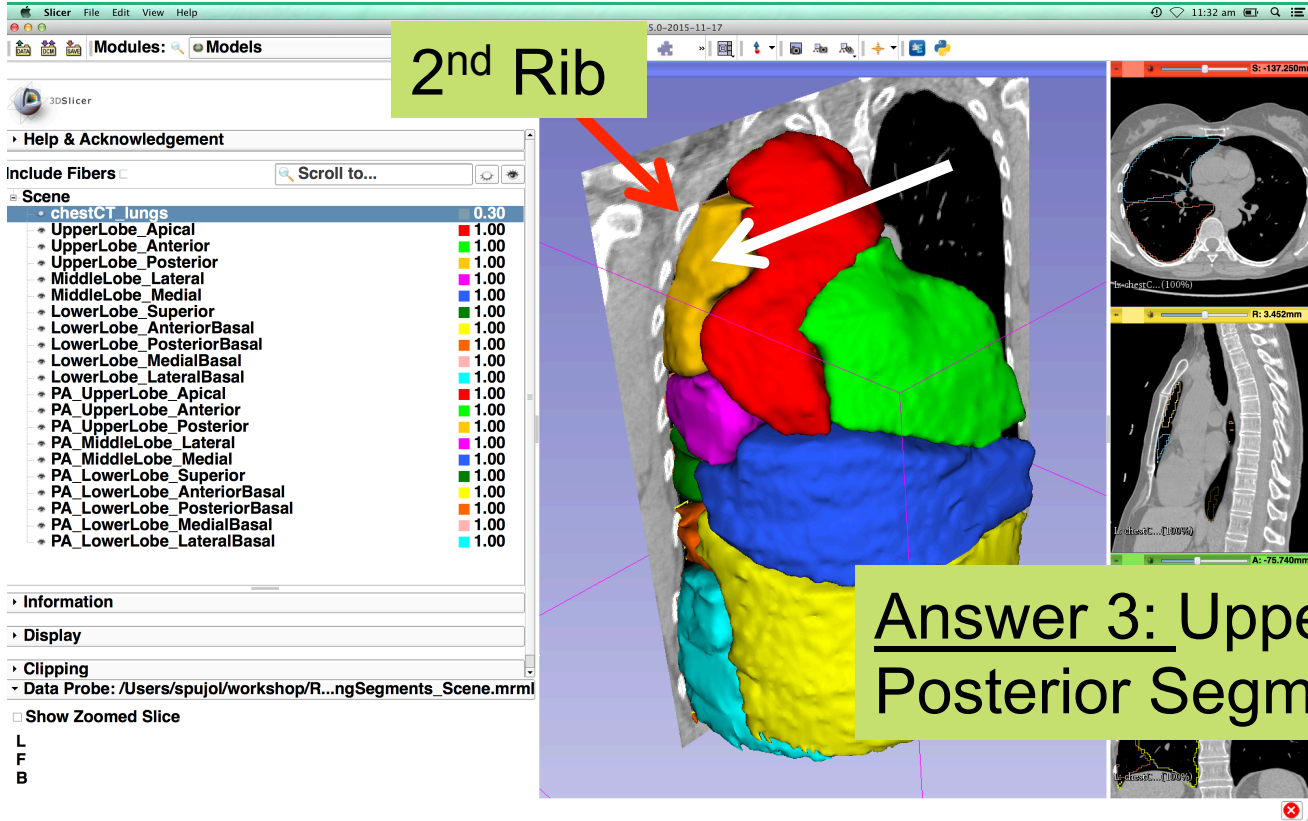



Lung Segments

Question 4:
Which segment abuts the distant oesophagus?

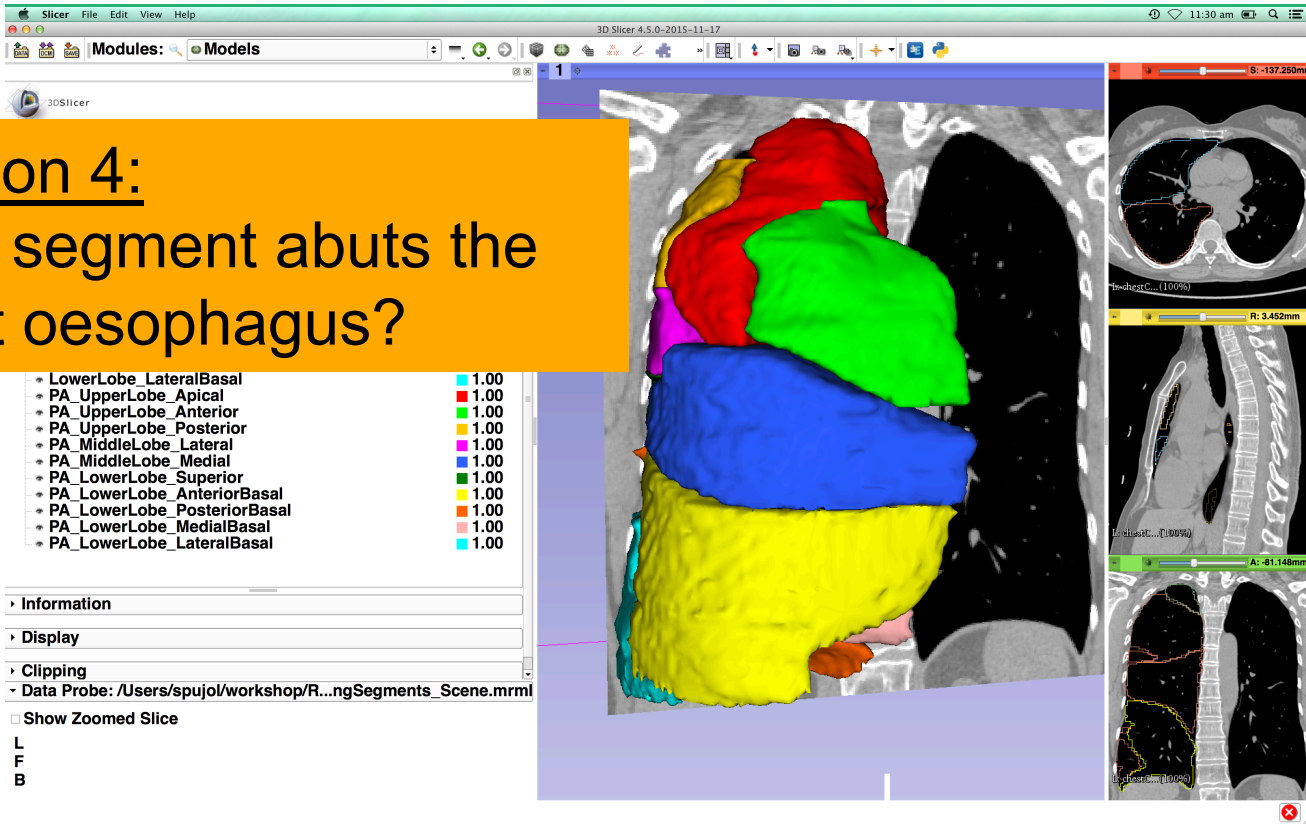



Lung Segments

3D Slicer 4.5.0-2015-11-17

Modules: Models

3DSlicer

Help & Acknowledgement

Include Fibers Scroll to...

Scene

- chestCT_lungs 0.30
 - UpperLobe_Apical 1.00
 - UpperLobe_Anterior 1.00
 - UpperLobe_Posterior 1.00
 - MiddleLobe_Lateral 1.00
 - MiddleLobe_Medial 1.00
 - LowerLobe_Superior 1.00
 - LowerLobe_AnteriorBasal 1.00
 - LowerLobe_PosteriorBasal 1.00
 - LowerLobe_MedialBasal 1.00
 - LowerLobe_LateralBasal 1.00
 - PA_UpperLobe_Apical 1.00
 - PA_UpperLobe_Anterior 1.00
 - PA_UpperLobe_Posterior 1.00
 - PA_MiddleLobe_Lateral 1.00
 - PA_MiddleLobe_Medial 1.00
 - PA_LowerLobe_Superior 1.00
 - PA_LowerLobe_AnteriorBasal 1.00
 - PA_LowerLobe_PosteriorBasal 1.00
 - PA_LowerLobe_MedialBasal 1.00
 - PA_LowerLobe_LateralBasal 1.00

Information

Display

Clipping

Data Probe: /Users/spujol/workshop/R...ngSegments_Scene.mrml

Show Zoomed Slice

L
F
B

oesophagus

Answer 4: Lower Lobe Medial Basal



Conclusion

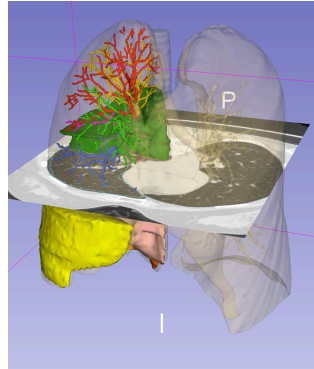
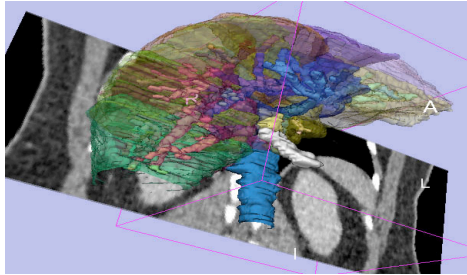
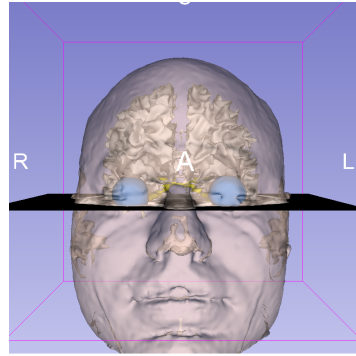
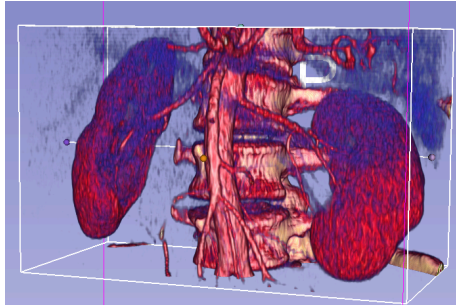

- 3D Slicer is an open source platform for medical imaging research
- Interactive interface to manipulate and visualize DICOM volumes, labelmaps and 3D models
- User-defined 3D views of the anatomy



Acknowledgments

- RSNA Research and Education Foundation
- Neuroimage Analysis Center (NAC)
(NIH P41 RR013218)
- National Center for Image-Guided Therapy (NCIGT)
(NIH U41 RR019703)



3D Slicer Exhibit – QIRR RSNA Learning Center (Lake Side)



3D Slicer: An Open-Source Software Platform for Segmentation, Registration, Quantitative Imaging and 3D Visualization of Multi-Modal Image Data

Sonia Pujol, PhD, Steve Pieper, PhD, Andriy Fedorov, PhD, Ron Kikinis, MD

www.slicer.org

contact: spujol@bwh.harvard.edu



About 3D Slicer

3D Slicer is a multi-platform, free, open source & extensible software package for 3D visualization and medical image computing. The software platform is community created for the purpose of subject specific medical image analysis and visualization.

- Multi-modality imaging including MRI, CT, US, nuclear medicine, and microscopy
- Multi organ from head to toe
- Bidirectional interface for devices
- Expandable and interface to multiple toolkits

History: Slicer was initiated in 1998 as a Master's thesis project between the Surgical Planning Laboratory at the Brigham and Women's Hospital and the MIT Artificial Intelligence Laboratory. Slicer has been downloaded over 150,000 thousand times worldwide. A variety of publications were enabled by the Slicer software. The newest version of the software, Slicer version 4.8, was released in November 2015.

Licenses: Slicer executables and source code are available under a BSD-style, free open source licensing agreement under which there are no reciprocity requirements, no restrictions on use, and no guarantees of performance.

Disclaimer: 3D Slicer is not FDA approved or CE marked, and is for research use only.



3D Slicer supports plug-ins called Slicer Extensions available from the Slicer Extension Manager. Developers can easily integrate special-purpose code to the platform, and end-users can select the extensions useful to their clinical research applications.

Segmentation & Registration

Segmentation is required for defining features of interest in imaging data for quantification and analysis.

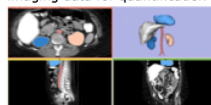

- 3D Slicer has a variety of interactive and automated segmentation methods:
- support for manual contouring and editing
 - region growing and level sets
 - graph cuts with gesture support
 - skull stripping and hierarchical brain segmentation for morphological studies
- The desktop application provides interactive visualization of the results and an intuitive GUI.

Timeseries analysis and multi-subject analysis require good registration of imaging data acquired at different times, on different scanners, and across modalities.

Slicer provides a variety of registration methods and resources to support versatile applications:

- Deformation models: rigid, affine, non-rigid, fluid
- Algorithm types: fiducial, surface, intensity-based
- Image types: scalar, vector, tensor

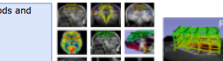

Google "na-mic registration documentation" for the extensive collection of Slicer registration cases and recipes.

Multi-modality Visualization

3D Slicer integrates standard radiological viewing capabilities for MR, CT, PET and Ultrasound data in multiple image file formats, including DICOM. A combined visualization of multiple imaging modalities and derived data can provide clinician scientists with an integrated understanding of anatomy and pathology.

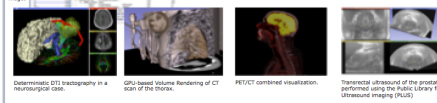
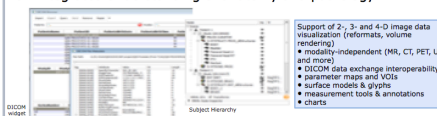

Quantitative Analysis

Many hundreds of imaging biomarkers are used in clinical practice, drug discovery and development. A free and open source platform can improve access to standard methods of image quantification and rapidly translate experimental methods into the clinical research setting for validation and refinement.

- 3D Slicer includes tools to quantify:
- PET/CT studies (SUV body weight)
 - Tumor growth (experimental)
 - Tumor response to treatment (measurements for RECIST)
 - DCE-MRI (pharmacokinetics)

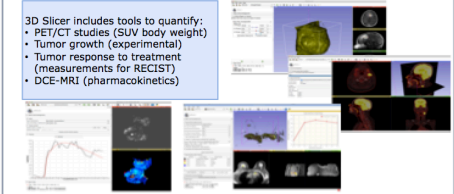

Clinical Research Applications

3D Slicer has been used in clinical research, with IRB clinical protocols appropriately created and managed. The extensible architecture of the software allows the development of specialized packages such as SlicerRT for radiotherapy research, and SlicerIGT for image-guided therapy.

In image-guided therapy (IGT) research, Slicer is frequently used to construct and visualize collections of MRI data that are available pre- and intra-operatively, and to display the tracked spatial position of surgical instruments.



Community, Training & Support

To support user and developer communities and the effective translation of tools into the clinical research setting, the 3D Slicer Project provides many outreach materials and activities

- Hands-on training workshops
- Tutorial materials & datasets
- DataStore extension for easy upload and download from database of anonymized datasets
- Reference style documentation
- User and developer mailing lists
- Project week events for developers

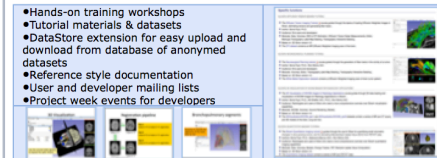

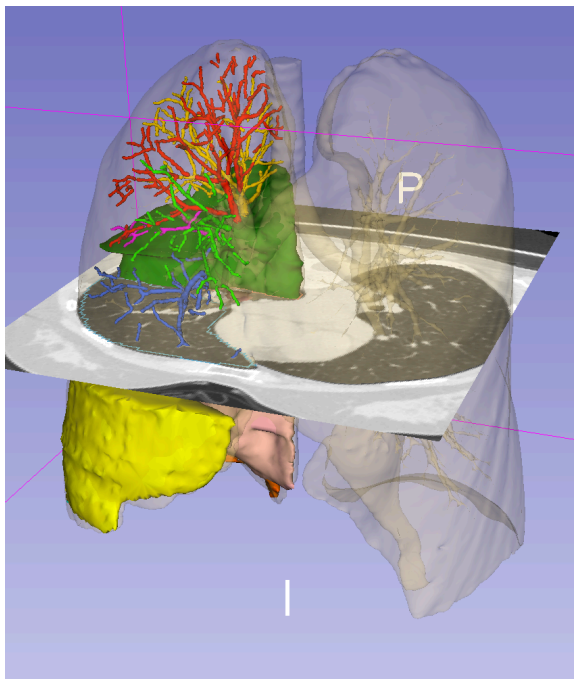

www.slicer.org

Questions and comments:
spujol@bwh.harvard.edu